A close-up photograph of a hand holding a purple, rectangular storage case. The hand is positioned at the top and right, with fingers gripping the edges. The case is shown from a slightly angled perspective, revealing its depth and the internal structure. The background is a solid, dark black, which makes the purple case stand out. The lighting is dramatic, highlighting the texture of the skin and the smooth surface of the plastic.

MO LO SPAZIO EDUCHIAM

SERIE STORAGE ATHENA

- PER SISTEMI DI STOCCAGGIO AUTOMATIZZATI
- PER MOVIMENTAZIONE AUTOMATIZZATA
- PER MOVIMENTAZIONE MANUALE
- RESISTENTI AGLI URTI
- RESISTENTI AGLI OLII



Robuste e resistenti ad alte e basse temperature



Buona resistenza agli olii



Le cassette marchiate con questo simbolo sono idonee al contatto con alimenti



COPERCHI IN ABS PER CASSETTE ATHENA SU PALLET



■ 07

COD. ART.

DIM. mm

F VW 0006 00 07

1200x1000x70

Colore di serie ■



Esempio di utilizzo del coperchio e del pallet



■ 07

COD. ART.

DIM. mm

F VW 0007 00 07

1200x800x70

Colore di serie ■

GRIGIO
F. 01

NERO
F. 07

LEGENDA ■



Le cassette contrassegnate con questo simbolo sono idonee al contatto con gli alimenti.



Le cassette contrassegnate con questo simbolo sono realizzate in materiale plastico completamente riciclabile.



DIMENSIONI = 300x200 mm

SERIE STORAGE ATHENA

PALLETS IN PLASTICA



COD. ART.	DIM. esterne mm
F PU 2240 00 13	1200x800x150 h
Portata su piano kg	4000
Portata su forche kg	1500
Peso kg	13,70

COD. ART.	DIM. esterne mm
F PU 3240 00 13	1200x1000x150 h
Portata su piano kg	4000
Portata su forche kg	1500
Peso kg	16,70

Pallets in plastica per cassette **Athena** e **Thema** con bordi in acciaio zincato sui 4 lati



COD. ART.	DIM. mm
F PA 2451 A0 01	300x200x120 h
Dim. esterne mm	300x200x120 h
Dim. interne mm	260x160x100 h
Capacità litri	5
Peso gr.	450
Colori di serie*	■
Fondo	chiuso
Pareti lunghe	chiuso
Pareti corte	chiuso
Maniglie	chiuso

Porta etichette: ART. **F PZ 0010 00 99**
Vedi pag. G15

■ *A richiesta disponibili altri colori



COD. ART.	DIM. mm
F PA 2851 A0 01	300x200x170 h
Dim. esterne mm	300x200x170 h
Dim. interne mm	258x160x154 h
Capacità litri	7
Peso gr.	670
Colori di serie*	■
Fondo	chiuso
Pareti lunghe	chiuso
Pareti corte	chiuso
Maniglie	chiuso

Porta etichette: ART. **F PZ 0010 00 99**
Vedi pag. G15

■ *A richiesta disponibili altri colori

CARRELLO CON CASSETTE

COD. ART.	DIM. mm
F LB B103 53 52	1023x613x1430 h
Completo di:	
1 carrello ART. F LB B103 03 52	
2 ruote girevoli con freno Ø 125 mm	
2 ruote fisse in gomma standard Ø 125 mm	
3 mensole profondità 420 mm	
5 cassette ART. F PA 4451 A0 01	
2 cassette ART. F PA 6451 A0 01	
2 cassette ART. F PA 6851 A0 01	
Portata 300 kg (150 kg per lato)	

■ Ulteriori informazioni vedi pag. D2



COD. ART. **F LB B103 53 52**

■ LEGENDA



Le cassette contrassegnate con questo simbolo sono idonee al contatto con gli alimenti.



Le cassette contrassegnate con questo simbolo sono realizzate in materiale plastico completamente riciclabile.



GRIGIO
F. 01

SERIE STORAGE ATHENA

■ 01

**COD. ART.**

DIM. mm

F PA 3251 AO 01 400x300x55 h

Dim. esterne mm 400x300x55 h

Dim. interne mm 355x254x37 h

Capacità litri 3,8

Peso gr. 505

Colori di serie* ■

Fondo **chiuso**Pareti lunghe **chiuso**Pareti corte **chiuso**Maniglie **chiuso**Porta etichette: ART. **F PZ 0010 00 99**

Vedi pag. G15

■ 01

**COD. ART.**

DIM. mm

F PA 3651 AO 01 400x300x78 h

Dim. esterne mm 400x300x78 h

Dim. interne mm 355x255x59 h

Capacità litri 6

Peso gr. 550

Colori di serie* ■

Fondo **chiuso**Pareti lunghe **chiuso**Pareti corte **chiuso**Maniglie **chiuso**Porta etichette: ART. **F PZ 0010 00 99**

Vedi pag. G15

■ 01

**COD. ART.**

DIM. mm

F PA 4051 AO 01 400x300x120 h

Dim. esterne mm 400x300x120 h

Dim. interne mm 357x257x102 h

Capacità litri 10

Peso gr. 770

Colori di serie* ■

Fondo **chiuso**Pareti lunghe **chiuso**Pareti corte **chiuso**Maniglie **chiuso**Porta etichette: ART. **F PZ 0010 00 99**

Vedi pag. G15

■ 01



Fondo rinforzato

COD. ART.

DIM. mm

F PA 4151 AO 01 400x300x125 h

Dim. esterne mm 400x300x125 h

Dim. interne mm 357x256x94 h

Capacità litri 10

Peso gr. 1005

Colori di serie* ■

Fondo **rinforzato**Pareti lunghe **chiuso**Pareti corte **chiuso**Maniglie **chiuso**Porta etichette: ART. **F PZ 0010 00 99**

Vedi pag. G15

■ 01

**COD. ART.**

DIM. mm

F PA 4051 EO 01 400x300x120 h

Dim. esterne mm 400x300x120 h

Dim. interne mm 357x256x99 h

Capacità litri 10

Peso gr. 820

Colori di serie* ■

Fondo **forato**Pareti lunghe **forate**Pareti corte **chiuso**Maniglie **chiuso**Porta etichette: ART. **F PZ 0010 00 99**

Vedi pag. G15

■ 01

**COD. ART.**

DIM. mm

F PA 4451 AO 01 400x300x170 h

Dim. esterne mm 400x300x170 h

Dim. interne mm 357x257x152 h

Capacità litri 15

Peso gr. 1070

Colori di serie* ■

Fondo **chiuso**Pareti lunghe **chiuso**Pareti corte **chiuso**Maniglie **chiuso**Porta etichette: ART. **F PZ 0010 00 99**,ART. **F PZ 9551 00 07**. Vedi pag. G15

■ *A richiesta disponibili altri colori

GRIGIO
F. 01

LEGENDA ■



Le cassette contrassegnate con questo simbolo sono idonee al contatto con gli alimenti.



Le cassette contrassegnate con questo simbolo sono realizzate in materiale plastico completamente riciclabile.



DIMENSIONI = 400x300 mm

SERIE STORAGE ATHENA



COD. ART.	DIM. mm
F PA 4551 AO 01	400x300x178 h
Dim. esterne mm	400x300x178 h
Dim. interne mm	357x255x145 h
Capacità litri	15
Peso gr.	1485
Colori di serie*	■
Fondo	rinforzato
Pareti lunghe	chiuse
Pareti corte	chiuse
Maniglie	chiuse
Porta etichette: ART. F PZ 0010 00 99 , ART. F PZ 9551 00 07 . Vedi pag. G15	



COD. ART.	DIM. mm
F PA 4851 AO 01	400x300x220 h
Dim. esterne mm	400x300x220 h
Dim. interne mm	357x258x207 h
Capacità litri	20
Peso gr.	1230
Colori di serie*	■
Fondo	chiuso
Pareti lunghe	chiuse
Pareti corte	chiuse
Maniglie	chiuse
Porta etichette: ART. F PZ 0010 00 99 , ART. F PZ 9551 00 07 . Vedi pag. G15	



COD. ART.	DIM. mm
F PA 4851 BO 01	400x300x220 h
Dim. esterne mm	400x300x220 h
Dim. interne mm	357x258x206 h
Capacità litri	20
Peso gr.	1200
Colori di serie*	■
Fondo	chiuso
Pareti lunghe	chiuse
Pareti corte	chiuse
Maniglie	aperte
Porta etichette: ART. F PZ 0010 00 99 , ART. F PZ 9551 00 07 . Vedi pag. G15	



COD. ART.	DIM. mm
F PA 4951 BO 01	400x300x230 h
Dim. esterne mm	400x300x230 h
Dim. interne mm	356x257x197 h
Capacità litri	20
Peso gr.	1390
Colori di serie*	■
Fondo	rinforzato
Pareti lunghe	chiuse
Pareti corte	chiuse
Maniglie	aperte
Porta etichette: ART. F PZ 0010 00 99 , ART. F PZ 9551 00 07 . Vedi pag. G15	



COD. ART.	DIM. mm
F PA 5251 AO 01	400x300x325 h
Dim. esterne mm	400x300x325 h
Dim. interne mm	356x255x307 h
Capacità litri	30
Peso gr.	2050
Colori di serie*	■
Fondo	chiuso
Pareti lunghe	chiuse
Pareti corte	chiuse
Maniglie	chiuse
Porta etichette: ART. F PZ 0010 00 99 , ART. F PZ 9551 00 07 . Vedi pag. G15	



COD. ART.	DIM. mm
F PA 5251 BO 01	400x300x325 h
Dim. esterne mm	400x300x325 h
Dim. interne mm	355x255x305 h
Capacità litri	30
Peso gr.	2020
Colori di serie*	■
Fondo	chiuso
Pareti lunghe	chiuse
Pareti corte	chiuse
Maniglie	aperte
Porta etichette: ART. F PZ 0010 00 99 , ART. F PZ 9551 00 07 . Vedi pag. G15	

■ *A richiesta disponibili altri colori

Serie di cassette Athena
ART. **F PA 6851 BO 01**



■ LEGENDA



Le cassette contrassegnate con questo simbolo sono idonee al contatto con gli alimenti.



Le cassette contrassegnate con questo simbolo sono realizzate in materiale plastico completamente riciclabile.



GRIGIO
F. 01

SERIE STORAGE ATHENA



■ 01

COD. ART. DIM. mm

F PA 5651 AO 01 600x400x76 h

Dim. esterne mm 600x400x76 h

Dim. interne mm 555x353x58 h

Capacità litri 10

Peso gr. 1435

Colori di serie* ■

Fondo **chiuso**Pareti lunghe **chiuso**Pareti corte **chiuso**Maniglie **chiuso**

Porta etichette: ART. F PZ 0010 00 99

Vedi pag. G15



■ 01

COD. ART. DIM. mm

F PA 6051 AO 01 600x400x120 h

Dim. esterne mm 600x400x120 h

Dim. interne mm 557x357x102 h

Capacità litri 20

Peso gr. 1585

Colori di serie* ■

Fondo **chiuso**Pareti lunghe **chiuso**Pareti corte **chiuso**Maniglie **chiuso**

Porta etichette: ART. F PZ 0010 00 99

Vedi pag. G15



■ 01

COD. ART. DIM. mm

F PA 6151 AO 01 600x400x120 h

Dim. esterne mm 600x400x120 h

Dim. interne mm 555x354x97 h

Capacità litri 20

Peso gr. 1685

Colori di serie* ■

Fondo **rinforzato**Pareti lunghe **chiuso**Pareti corte **chiuso**Maniglie **chiuso**

Porta etichette: ART. F PZ 0010 00 99

Vedi pag. G15



■ 01

COD. ART. DIM. mm

F PA 6051 CO 01 600x400x120 h

Dim. esterne mm 600x400x120 h

Dim. interne mm 557x356x102 h

Capacità litri 20

Peso gr. 1575

Colori di serie* ■

Fondo **chiuso**Pareti lunghe **forate**Pareti corte **chiuso**Maniglie **chiuso**

Porta etichette: ART. F PZ 0010 00 99

Vedi pag. G15



■ 01

COD. ART. DIM. mm

F PA 6051 EO 01 600x400x120 h

Dim. esterne mm 600x400x120 h

Dim. interne mm 557x357x103 h

Capacità litri 20

Peso gr. 1500

Colori di serie* ■

Fondo **forato**Pareti lunghe **forate**Pareti corte **chiuso**Maniglie **chiuso**

Porta etichette: ART. F PZ 0010 00 99

Vedi pag. G15



CARRELLO

COD. ART. DIM. mm

F CP 2011 02 99 615x415x170/870 hCarrello con 4 ruote girevoli **senza freni** Ø 100 mm in gomma standard

Portata 150 kg

senza cassette

■ Ulteriori informazioni vedi pag. E8

GRIGIO
F. 01

LEGENDA ■



Le cassette contrassegnate con questo simbolo sono idonee al contatto con gli alimenti.



Le cassette contrassegnate con questo simbolo sono realizzate in materiale plastico completamente riciclabile.

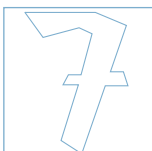

DIMENSIONI = 600x400 mm

SERIE STORAGE ATHENA



COD. ART.	DIM. mm
F PA 6451 AO 01	600x400x170 h
Dim. esterne mm	600x400x170 h
Dim. interne mm	560x358x153 h
Capacità litri	30
Peso gr.	2125
Colori di serie*	■
Fondo	chiuso
Pareti lunghe	chiuso
Pareti corte	chiuso
Maniglie	chiuso

Porta etichette: ART. F PZ 0010 00 99,
ART. F PZ 9751 00 07. Vedi pag. G15



COD. ART.	DIM. mm
F PA 6551 AO 01	600x400x170 h
Dim. esterne mm	600x400x170 h
Dim. interne mm	558x358x139 h
Capacità litri	30
Peso gr.	2330
Colori di serie*	■
Fondo	rinforzato
Pareti lunghe	chiuso
Pareti corte	chiuso
Maniglie	chiuso

Porta etichette: ART. F PZ 0010 00 99,
ART. F PZ 9751 00 07. Vedi pag. G15



COD. ART.	DIM. mm
F PA 6851 AO 01	600x400x220 h
Dim. esterne mm	600x400x220 h
Dim. interne mm	558x356x202 h
Capacità litri	40
Peso gr.	2620
Colori di serie*	■
Fondo	chiuso
Pareti lunghe	chiuso
Pareti corte	chiuso
Maniglie	aperte

Porta etichette: ART. F PZ 0010 00 99,
ART. F PZ 9751 00 07. Vedi pag. G15



COD. ART.	DIM. mm
F PA 6851 BO 01	600x400x220 h
Dim. esterne mm	600x400x220 h
Dim. interne mm	558x357x202 h
Capacità litri	40
Peso gr.	2570
Colori di serie*	■
Fondo	chiuso
Pareti lunghe	chiuso
Pareti corte	chiuso
Maniglie	aperte

Porta etichette: ART. F PZ 0010 00 99,
ART. F PZ 9751 00 07. Vedi pag. G15



COD. ART.	DIM. mm
F PA 6951 BO 01	600x400x220 h
Dim. esterne mm	600x400x220 h
Dim. interne mm	560x358x188 h
Capacità litri	40
Peso gr.	2875
Colori di serie*	■
Fondo	rinforzato
Pareti lunghe	chiuso
Pareti corte	chiuso
Maniglie	aperte

Porta etichette: ART. F PZ 0010 00 99,
ART. F PZ 9751 00 07. Vedi pag. G15



COD. ART.	DIM. mm
F PA 6851 FO 01	600x400x220 h
Dim. esterne mm	600x400x220 h
Dim. interne mm	557x356x202 h
Capacità litri	40
Peso gr.	2480
Colori di serie*	■
Fondo	forato
Pareti lunghe	forate
Pareti corte	forate
Maniglie	aperte

Porta etichette: ART. F PZ 0010 00 99,
ART. F PZ 9751 00 07. Vedi pag. G15

■ *A richiesta disponibili altri colori

CARRELLO

COD. ART.

F CR 0441 00 04

Carrello con 2 ruote girevoli in gomma Ø 125 mm,
2 ruote fisse in poliuretano Ø 125 mm

Portata 300 kg

Solo per infornamento cassette serie Athena ed
Odette 600x400 mm

■ Ulteriori informazioni vedi pag. G15



■ LEGENDA



Le cassette contrassegnate con questo simbolo sono idonee al
contatto con gli alimenti.



Le cassette contrassegnate con questo simbolo sono realizzate in
materiale plastico completamente riciclabile.



GRIGIO
F. 01

SERIE STORAGE ATHENA



COD. ART.	DIM. mm
F PA 7251 AO 01	600x400x285 h
Dim. esterne mm	600x400x285 h
Dim. interne mm	557x356x263 h
Capacità litri	53
Peso gr.	2765
Colori di serie*	■
Fondo	chiuso
Pareti lunghe	chiuso
Pareti corte	chiuso
Maniglie	chiuso
Porta etichette: ART. F PZ 0010 00 99 , ART. F PZ 9751 00 07 . Vedi pag. G15	



COD. ART.	DIM. mm
F PA 7251 BO 01	600x400x285 h
Dim. esterne mm	600x400x285 h
Dim. interne mm	557x357x263 h
Capacità litri	53
Peso gr.	2895
Colori di serie*	■
Fondo	chiuso
Pareti lunghe	chiuso
Pareti corte	chiuso
Maniglie	aperte
Porta etichette: ART. F PZ 0010 00 99 , ART. F PZ 9751 00 07 . Vedi pag. G15	



COD. ART.	DIM. mm
F PA 7351 BO 01	600x400x285 h
Dim. esterne mm	600x400x285 h
Dim. interne mm	557x357x256 h
Capacità litri	53
Peso gr.	3120
Colori di serie*	■
Fondo	rinforzato
Pareti lunghe	chiuso
Pareti corte	chiuso
Maniglie	aperte
Porta etichette: ART. F PZ 0010 00 99 , ART. F PZ 9751 00 07 . Vedi pag. G15	



COD. ART.	DIM. mm
F PA 7651 AO 01	600x400x325 h
Dim. esterne mm	600x400x325 h
Dim. interne mm	558x358x308 h
Capacità litri	60
Peso gr.	3315
Colori di serie*	■
Fondo	chiuso
Pareti lunghe	chiuso
Pareti corte	chiuso
Maniglie	chiuso
Porta etichette: ART. F PZ 0010 00 99 , ART. F PZ 9751 00 07 . Vedi pag. G15	



COD. ART.	DIM. mm
F PA 7651 BO 01	600x400x325 h
Dim. esterne mm	600x400x325 h
Dim. interne mm	558x357x308 h
Capacità litri	60
Peso gr.	3215
Colori di serie*	■
Fondo	chiuso
Pareti lunghe	chiuso
Pareti corte	chiuso
Maniglie	aperte
Porta etichette: ART. F PZ 0010 00 99 , ART. F PZ 9751 00 07 . Vedi pag. G15	



COD. ART.	DIM. mm
F PA 7751 BO 01	600x400x325 h
Dim. esterne mm	600x400x325 h
Dim. interne mm	558x358x295 h
Capacità litri	60
Peso gr.	3630
Colori di serie*	■
Fondo	rinforzato
Pareti lunghe	chiuso
Pareti corte	chiuso
Maniglie	aperte
Porta etichette: ART. F PZ 0010 00 99 , ART. F PZ 9751 00 07 . Vedi pag. G15	

■ *A richiesta disponibili altri colori

GRIGIO
F. 01

LEGENDA ■



Le cassette contrassegnate con questo simbolo sono idonee al contatto con gli alimenti.



Le cassette contrassegnate con questo simbolo sono realizzate in materiale plastico completamente riciclabile.



DIMENSIONI = 600x400 mm

SERIE STORAGE ATHENA



COD. ART.	DIM. mm
F PA 7651 DO 01	600x400x325 h
Dim. esterne mm	600x400x325 h
Dim. interne mm	558x358x308 h
Capacità litri	60
Peso gr.	3040
Colori di serie*	■
Fondo	chiuso
Pareti lunghe	forate
Pareti corte	forate
Maniglie	aperte

Porta etichette: ART. **F PZ 0010 00 99**,
ART. **F PZ 9751 00 07**. Vedi pag. G15

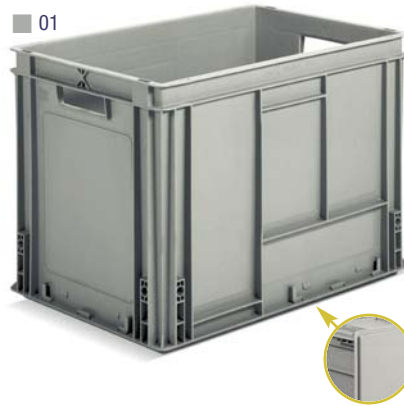

COD. ART.	DIM. mm
F PA 8051 BO 01	600x400x430 h
Dim. esterne mm	600x400x430 h
Dim. interne mm	557x356x415 h
Capacità litri	90
Peso gr.	3915
Colori di serie*	■
Fondo	chiuso
Pareti lunghe	chiuse
Pareti corte	chiuse
Maniglie	aperte

Porta etichette: ART. **F PZ 0010 00 99**,
ART. **F PZ 9751 00 07**. Vedi pag. G15

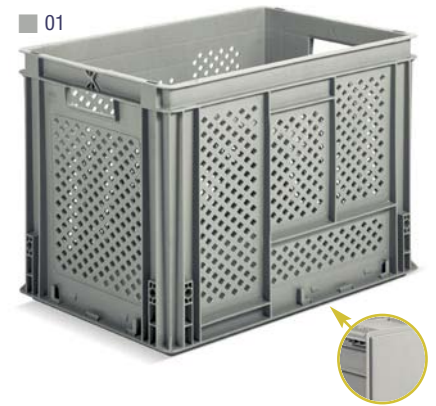

COD. ART.	DIM. mm
F PA 8051 DO 01	600x400x430 h
Dim. esterne mm	600x400x430 h
Dim. interne mm	557x357x415 h
Capacità litri	90
Peso gr.	3610
Colori di serie*	■
Fondo	chiuso
Pareti lunghe	forate
Pareti corte	forate
Maniglie	aperte

Porta etichette: ART. **F PZ 0010 00 99**,
ART. **F PZ 9751 00 07**. Vedi pag. G15

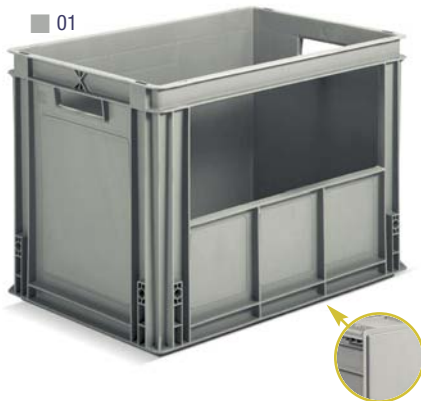

COD. ART.	DIM. mm
F PA 8051 SO 01	600x400x430 h
Dim. esterne mm	600x400x430 h
Dim. interne mm	557x357x415 h
Dim. finestra mm	462x180 h
Capacità litri	90
Peso gr.	3625
Colori di serie*	■
Fondo	chiuso
Pareti lunghe	chiuse
Pareti corte	chiuse
Maniglie	aperte

Porta etichette: ART. **F PZ 0010 00 99**,
ART. **F PZ 9751 00 07**. Vedi pag. G15



COD. ART.	DIM. mm
F PA 8051 RO 01	600x400x430 h
Dim. esterne mm	600x400x430 h
Dim. interne mm	557x357x415 h
Dim. finestra mm	260x183 h
Capacità litri	90
Peso gr.	3780
Colori di serie*	■
Fondo	chiuso
Pareti lunghe	chiuse
Pareti corte	chiuse
Maniglie	aperte

Porta etichette: ART. **F PZ 0010 00 99**,
ART. **F PZ 9751 00 07**. Vedi pag. G15



COD. ART.	DIM. mm
F PA 8151 BO 01	600x400x430 h
Dim. esterne mm	600x400x430 h
Dim. interne mm	557x357x415 h
Capacità litri	90
Peso gr.	4210
Colori di serie*	■
Fondo	rinforzato
Pareti lunghe	chiuse
Pareti corte	chiuse
Maniglie	aperte

Porta etichette: ART. **F PZ 0010 00 99**,
ART. **F PZ 9751 00 07**. Vedi pag. G15

■ *A richiesta disponibili altri colori

■ LEGENDA



Le cassette contrassegnate con questo simbolo sono idonee al contatto con gli alimenti.



Le cassette contrassegnate con questo simbolo sono realizzate in materiale plastico completamente riciclabile.



GRIGIO
F. 01

SERIE STORAGE ATHENA



Fondo rinforzato



Fondo rinforzato



Fondo rinforzato

COD. ART.

DIM. mm

F PA 8551 AO 01 800x600x120 h

Dim. esterne mm 800x600x120 h

Dim. interne mm 757x557x86 h

Capacità litri 49

Peso gr. 3450

Colori di serie* ■

Fondo **rinforzato**Pareti lunghe **chiuse**Pareti corte **chiuse**Maniglie **chiuse**Porta etichette: ART. **F PZ 0010 00 99**

Vedi pag. G15

COD. ART.

DIM. mm

F PA 8751 AO 01 800x600x170 h

Dim. esterne mm 800x600x170 h

Dim. interne mm 758x555x137 h

Capacità litri 69

Peso gr. 3920

Colori di serie* ■

Fondo **rinforzato**Pareti lunghe **chiuse**Pareti corte **chiuse**Maniglie **chiuse**Porta etichette: ART. **F PZ 0010 00 99**,ART. **F PZ 9751 00 07**. Vedi pag. G15

COD. ART.

DIM. mm

F PA 8951 AO 01 800x600x220 h

Dim. esterne mm 800x600x220 h

Dim. interne mm 757x556x188 h

Capacità litri 90

Peso gr. 4630

Colori di serie* ■

Fondo **rinforzato**Pareti lunghe **chiuse**Pareti corte **chiuse**Maniglie **chiuse**Porta etichette: ART. **F PZ 0010 00 99**,ART. **F PZ 9751 00 07**. Vedi pag. G15

Fondo rinforzato



Fondo rinforzato

COD. ART.

DIM. mm

F PA 9351 AO 01 800x600x325 h

Dim. esterne mm 800x600x325 h

Dim. interne mm 756x555x294 h

Capacità litri 130

Peso gr. 5100

Colori di serie* ■

Fondo **rinforzato**Pareti lunghe **chiuse**Pareti corte **chiuse**Maniglie **chiuse**Porta etichette: ART. **F PZ 0010 00 99**,ART. **F PZ 9751 00 07**. Vedi pag. G15

COD. ART.

DIM. mm

F PA 9751 AO 01 800x600x430 h

Dim. esterne mm 800x600x430 h

Dim. interne mm 756x555x395 h

Capacità litri 175

Peso gr. 6000

Colori di serie* ■

Fondo **rinforzato**Pareti lunghe **chiuse**Pareti corte **chiuse**Maniglie **chiuse**Porta etichette: ART. **F PZ 0010 00 99**,ART. **F PZ 9751 00 07**. Vedi pag. G15

■ Particolare del fondo rinforzato delle cassette 800x600 mm

■ *A richiesta disponibili altri colori

GRIGIO
F. 01

LEGENDA ■



Le cassette contrassegnate con questo simbolo sono idonee al contatto con gli alimenti.



Le cassette contrassegnate con questo simbolo sono realizzate in materiale plastico completamente riciclabile.



PP



DIMENSIONI = 800x600 mm

SERIE STORAGE ATHENA

CASSETTA COMPLETA DI 1 SET DI QUATTRO PIEDINI

- Fornita montata



COD. ART.	DIM. mm
F PA 8551 AD 01	800x600x220 h
Cassetta altezza mm 120	
Capacità litri 49	

COD. ART.	DIM. mm
F PA 8751 AD 01	800x600x270 h
Cassetta altezza mm 170	
Capacità litri 69	

COD. ART.	DIM. mm
F PA 8951 AD 01	800x600x320 h
Cassetta altezza mm 220	
Capacità litri 90	

COD. ART.	DIM. mm
F PA 9351 AD 01	800x600x425 h
Cassetta altezza mm 325	
Capacità litri 130	

COD. ART.	DIM. mm
F PA 9751 AD 01	800x600x530 h
Cassetta altezza mm 430	
Capacità litri 175	

CASSETTA COMPLETA DI 1 SET DI QUATTRO PIEDINI E 1 COPPIA TRAVERSE DI COLLEGAMENTO

- Fornita montata



COD. ART.	DIM. mm
F PA 8551 AE 01	800x600x245 h
Cassetta altezza mm 120	
Capacità litri 49	

COD. ART.	DIM. mm
F PA 8751 AE 01	800x600x295 h
Cassetta altezza mm 170	
Capacità litri 69	

COD. ART.	DIM. mm
F PA 8951 AE 01	800x600x345 h
Cassetta altezza mm 220	
Capacità litri 90	

COD. ART.	DIM. mm
F PA 9351 AE 01	800x600x450 h
Cassetta altezza mm 325	
Capacità litri 130	

COD. ART.	DIM. mm
F PA 9751 AE 01	800x600x555 h
Cassetta altezza mm 430	
Capacità litri 175	

CASSETTA COMPLETA DI 1 SET DI QUATTRO RUOTE GIREVOLI IN GOMMA Ø 100 mm

- Fornita montata



COD. ART.	DIM. mm
F PA 8551 AF 01	800x600x245 h
Cassetta altezza mm 120	
Capacità litri 49	

COD. ART.	DIM. mm
F PA 8751 AF 01	800x600x295 h
Cassetta altezza mm 170	
Capacità litri 69	

COD. ART.	DIM. mm
F PA 8951 AF 01	800x600x345 h
Cassetta altezza mm 220	
Capacità litri 90	

COD. ART.	DIM. mm
F PA 9351 AF 01	800x600x450 h
Cassetta altezza mm 325	
Capacità litri 130	

COD. ART.	DIM. mm
F PA 9751 AF 01	800x600x555 h
Cassetta altezza mm 430	
Capacità litri 175	



- I 4 piedini permettono, rientrando nella cassetta sottostante, l'impilamento delle cassette



- Le 2 traverse di collegamento permettono la sovrapposizione delle cassette



- Le 4 ruote permettono, rientrando nella cassetta sottostante, l'impilamento delle cassette

■ LEGENDA



Le cassette contrassegnate con questo simbolo sono idonee al contatto con gli alimenti.



Le cassette contrassegnate con questo simbolo sono realizzate in materiale plastico completamente riciclabile.

GRIGIO
F. 01

SERIE STORAGE ATHENA

COPERCHIO A CERNIERA SERIE F PA 300x200 / 400x300 / 600x400



Coperchio a cerniera

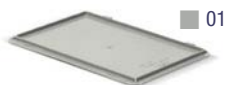

COD. ART.

Coperchio a cerniera mm

F PA 0351 00 01**300x200**

Peso gr. 155

Colori di serie* ■



COD. ART.

Coperchio a cerniera mm

F PA 0651 00 01**400x300**

Peso gr. 320

Colori di serie* ■



COD. ART.

Coperchio a cerniera mm

F PA 0951 00 01**600x400**

Peso gr. 722

Colori di serie* ■

COPERCHIO SERIE F PA 400x300 / 600x400 / 800x600



Coperchio con maniglie



COD. ART.

Coperchio mm

F PA 1B51 00 01**400x300**

Peso gr. 375

Colori di serie* ■



COD. ART.

Coperchio mm

F PA 1C51 00 01**600x400**

Peso gr. 750

Colori di serie* ■



COD. ART.

Coperchio mm

F PA 1251 01 01**800x600**

Peso gr. 1685

Colori di serie* ■

Per cassette articolo: F PA 8551 A0 01



COD. ART.

Coperchio mm

F PA 1251 00 01**800x600**

Peso gr. 1710

Colori di serie* ■

Per cassette articolo: F PA 8751 A0 01, F PA 8951 A0 01, F PA 9351 A0 01, F PA 9751 A0 01

■ *A richiesta disponibili altri colori

COPERCHIO SCORREVOLE SERIE F PA 400x300



Coperchio scorrevole



COD. ART.

Coperchio scorrevole mm

F PA 1651 00 01**400x300**

Peso gr. 440

Colori di serie* ■

■ Non idoneo per l'art. F PA 3251 A0 01

COD. ART. F PZ 0681 00 13

Coppie ganci a scorrimento adatte per coperchi a cerniera per cassette Serie Athena con altezza: 50/80/120/170/220/320/430 mm.

GRIGIO
F. 01

LEGENDA ■



Le cassette contrassegnate con questo simbolo sono idonee al contatto con gli alimenti.



Le cassette contrassegnate con questo simbolo sono realizzate in materiale plastico completamente riciclabile.

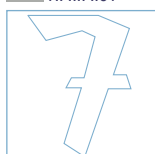

DIMENSIONI = 400x300 / 600x400 mm

SERIE STORAGE ATHENA

CASSETTE DIVISORIO PER SERIE ATHENA 400x300

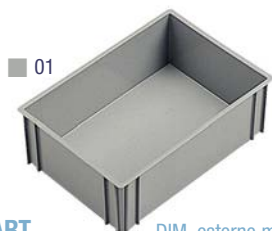

COD. ART. DIM. esterne mm
F PP 4051 00 01 256x178x90 h
Colori di serie ■

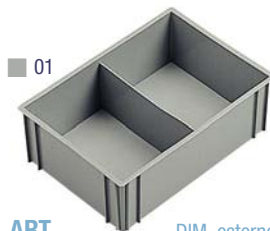

COD. ART. DIM. esterne mm
F PP 4551 00 01 256x178x90 h
Colori di serie ■

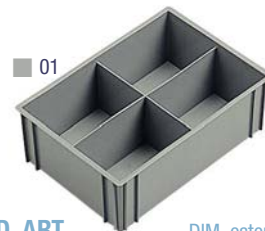

COD. ART. DIM. esterne mm
F PP 5051 00 01 256x178x90 h
Colori di serie ■

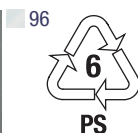

COD. ART. DIM. esterne mm
F PP 9368 00 96 252x178
Colore ■ trasparente



CASSETTA SUDDIVISA CON
1 ART. F PP 4051 00 01
1 ART. F PP 4551 00 01



CASSETTA SUDDIVISA CON
1 ART. F PP 4051 00 01
1 ART. F PP 5051 00 01



CASSETTA SUDDIVISA CON
1 ART. F PP 4551 00 01
1 ART. F PP 5051 00 01

CASSETTE DIVISORIO PER SERIE ATHENA - THEMA 600x400



COD. ART. DIM. esterne mm
F PP 6051 00 01 357x278x90 h
Colori di serie ■

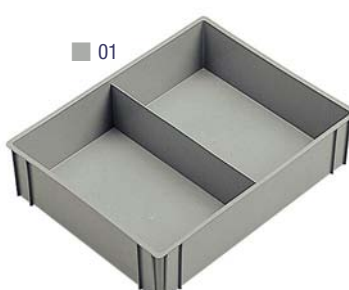

COD. ART. DIM. esterne mm
F PP 6551 00 01 357x278x90 h
Colori di serie ■

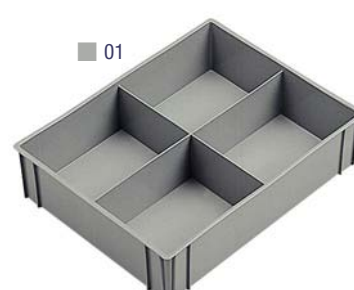

COD. ART. DIM. esterne mm
F PP 7051 00 01 357x278x90 h
Colori di serie ■

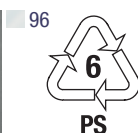

COD. ART. DIM. esterne mm
F PP 9668 00 96 358x278
Colore ■ trasparente



CASSETTA SUDDIVISA CON
1 ART. F PP 6051 00 01
1 ART. F PP 6551 00 01



CASSETTA SUDDIVISA CON
1 ART. F PP 6051 00 01
1 ART. F PP 7051 00 01



CASSETTA SUDDIVISA CON
1 ART. F PP 6551 00 01
1 ART. F PP 7051 00 01

■ LEGENDA



Le cassette contrassegnate con questo simbolo sono realizzate in materiale plastico completamente riciclabile.



■ TRASPARENTE
F. 96

■ GRIGIO
F. 01



SERIE STORAGE ATHENA

DIVISORI A PETTINE PER CASSETTE SERIE ATHENA - THEMA

SERIE mm 45 h

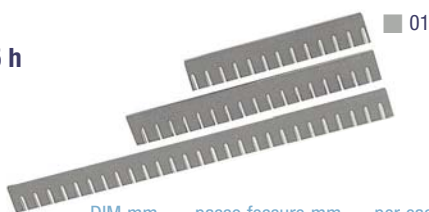

COD. ART.	DIM mm	passo fessure mm	per cassette serie
F HN 1320 00 01	255x45	20	400x300
F HN 1420 00 01	355x45	20	400x300 / 600x400
F HN 1620 00 01	555x45	20	600x400

SERIE mm 70 h

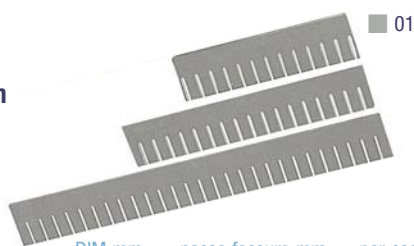

COD. ART.	DIM mm	passo fessure mm	per cassette serie
F HN 1340 00 01	255x70	20	400x300
F HN 1440 00 01	355x70	20	400x300 / 600x400
F HN 1640 00 01	555x70	20	600x400

SERIE mm 120 h

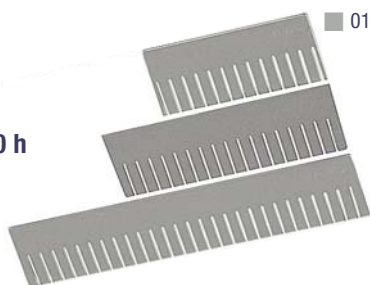

COD. ART.	DIM mm	passo fessure mm	per cassette serie
F HN 1360 00 01	255x120	20	400x300
F HN 1460 00 01	355x120	20	400x300 / 600x400
F HN 1660 00 01	555x120	20	600x400



SERIE mm 90 h

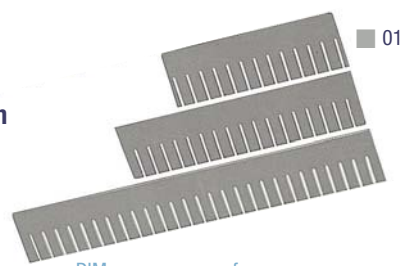

COD. ART.	DIM mm	passo fessure mm	per cassette serie
F HN 1350 00 01	255x90	20	400x300
F HN 1450 00 01	355x90	20	400x300 / 600x400
F HN 1650 00 01	555x90	20	600x400

SERIE mm 180 h

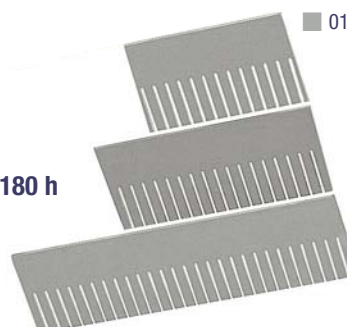

COD. ART.	DIM mm	passo fessure mm	per cassette serie
F HN 1370 00 01	255x180	20	400x300
F HN 1470 00 01	355x180	20	400x300 / 600x400
F HN 1670 00 01	555x180	20	600x400

PIANO INTERMEDIO

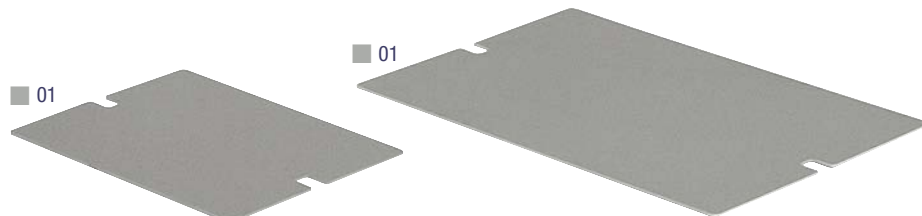

COD. ART.	DIM. mm
F HN 5130 00 01	355x255
Per cassette Athena	400x300
Colori di serie ■	

COD. ART.	DIM. mm
F HN 5140 00 01	555x355
Per cassette Athena-Thema	600x400
Colori di serie ■	

■ utilizzo del piano intermedio

GRIGIO
F. 01

INFO ■

www.famispa.com

PORTA ETICHETTE PER SERIE ATHENA E NETTUNO 400x300



COD. ART.	DIM. esterne mm
F PZ 9551 00 07	150x85

Colori di serie ■

ETICHETTE DI CARTA

COD. ART.	DIM. esterne mm
F PZ 0920 00 00	145x81

Quantità per foglio: 4

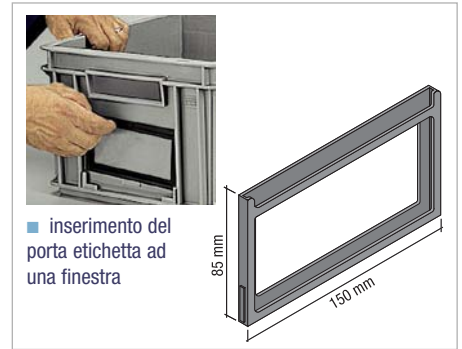

■ inserimento del porta etichetta ad una finestra

PORTA ETICHETTE PER SERIE ATHENA E NETTUNO 600x400



COD. ART.	DIM. esterne mm
F PZ 9751 00 07	215x85

Colori di serie ■

ETICHETTE DI CARTA

COD. ART.	DIM. esterne mm
F PZ 0940 00 00	210x81

Quantità per foglio: 3

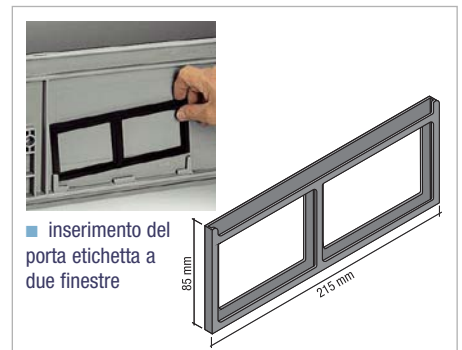

■ inserimento del porta etichetta a due finestre

MOLLA PORTA BOLLA PER SERIE ATHENA - THEMA - MINERVA



COD. ART. F PZ 0010 00 99



■ Esempio di utilizzo della molla porta bolle

CARRELLI PER IL TRASPORTO E SOLLEVAMENTO CASSETTE SERIE ATHENA - ODETTE 600x400 mm

COD. ART.	PORTATA kg
F CR 0441 00 04	300

Solo per inforcamento cassette serie Athena ed Odette 600x400 mm
2 ruote girevoli in gomma Ø 125 mm
2 ruote fisse in poliuretano Ø 125 mm

■ 04



■ Solo per inforcamento delle cassette serie Athena ed Odette 600x400 mm

sistema di trasporto

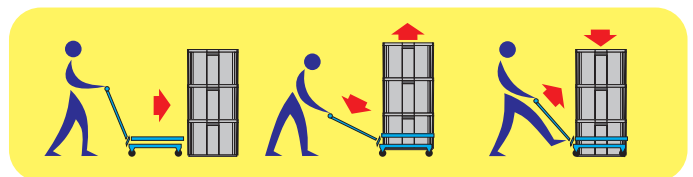

■ INFO

RAL 5012 F.04 ■ ZINCATO F.99 ■ NERO F.07



www.famispa.com



SERIE STORAGE ODETTTE KLT

- BUONA RESISTENZA AGLI OLII
- DIVERSE POSSIBILITÀ DI HANDLING AUTOMATIZZATO
- ROBUSTE MANIGLIE ERGONOMICHE
- OTTIMO GRADO DI SICUREZZA E RESISTENZA
- FONDO LISCIO PER LO SCORRIMENTO SILENZIOSO SUI NASTRI
- FONDO CON FORI PER IL DRENAGGIO DELL'ACQUA

**NEW**BLU
F.27

LEGENDA ■



Le cassette contrassegnate con questo simbolo sono realizzate in materiale plastico completamente riciclabile.



DIMENSIONI = 600x400 / 400x300 / 300x200 mm

SERIE STORAGE ODETTE KLT



COD. ART.	DIM. mm
F PC 7251 00 27	600x400x280 h
Dim. esterne mm	600x400x280 h
Dim. interne mm	544x359x262 h
Capacità litri	51,9
Peso gr.	2670
Fondo forato	
Colore di serie	■



COD. ART.	DIM. mm
F PC 5051 00 27	400x300x280 h
Dim. esterne mm	400x300x280 h
Dim. interne mm	346x260x262 h
Capacità litri	24,1
Peso gr.	1700
Fondo forato	
Colore di serie	■



COD. ART.	DIM. mm
F PC 6651 00 27	600x400x147,5 h
Dim. esterne mm	600x400x147,5 h
Dim. interne mm	544x359x129,5 h
Capacità litri	25,3
Peso gr.	1900
Fondo forato	
Colore di serie	■



COD. ART.	DIM. mm
F PC 4251 00 27	400x300x147,5 h
Dim. esterne mm	400x300x147,5 h
Dim. interne mm	346x260x129,5 h
Capacità litri	13,1
Peso gr.	1080
Fondo forato	
Colore di serie	■



COD. ART.	DIM. mm
F PC 2351 00 27	300x200x147,5 h
Dim. esterne mm	300x200x147,4 h
Dim. interne mm	243x162x129,7 h
Capacità litri	5,3
Peso gr.	570
Fondo NON forato	
Colore di serie	■

■ LEGENDA



Le cassette contrassegnate con questo simbolo sono realizzate in materiale plastico completamente riciclabile.



■ BLU
F.....27

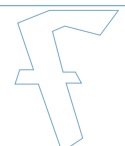

SERIE STORAGE ODETTA

- PER MOVIMENTAZIONE AUTOMATIZZATA
- RESISTENTI AGLI OLII
- PER SISTEMI DI STOCCAGGIO
- PER MOVIMENTAZIONE MANUALE

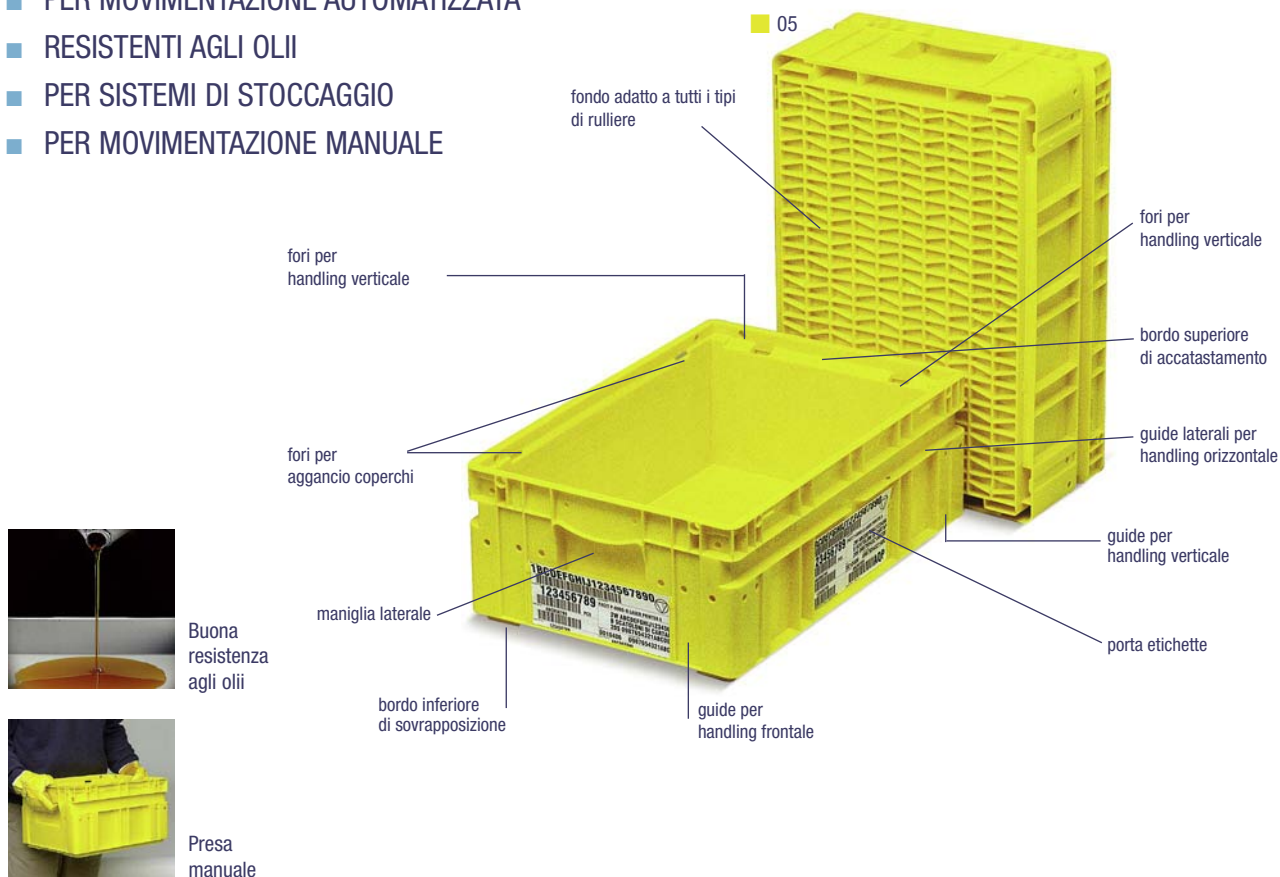

FAMI è l'unica azienda italiana produttrice di contenitori approvati dalla commissione europea "Odette". Tali cassette presentano le seguenti caratteristiche:

- 8 diverse possibilità di handling automatizzato;
- robuste maniglie ergonomiche;
- favorevole rapporto tra volume esterno e volume utile;
- fondo rinforzato e strutturato per scorrere agevolmente su tutti i tipi di rulliere;
- 2 porta etichette per etichette "bar code" formato A5 in standard "Odette";
- ottimo grado di sicurezza (coefficiente 3 rilevato nei vari crash test).

PALLET IN PLASTICA PER CASSETTE ODETTA

Pallet in plastica per cassette **Odette** con bordi in acciaio zincato sui 4 lati



COD. ART.

DIM. esterne mm

F PU 2140 00 13

1200x800x150 h

Portata su piano kg 4000

Portata su forche kg 1500

Peso kg 14,50

COD. ART.

DIM. esterne mm

F PU 3140 00 13

1200x1000x150 h

Portata su piano kg 4000

Portata su forche kg 1500

Peso kg 17,60

GIALLO
F. 05

ZINCATO F. 99

LEGENDA ■



Le cassette contrassegnate con questo simbolo sono realizzate in materiale plastico completamente riciclabile.



DIMENSIONI: 300x200 / 400x200 / 600x400 mm

SERIE STORAGE ODETTTE

CASSETTE ODETTTE SERIE F PC 300x200 / 400x300 / 600x400



05



COD. ART.	DIM. mm
F PC 2451 00 05	300x200x147,5 h
Dim. esterne mm	300x200x147,5 h
Dim. interne mm	234x158x126 h
Capacità litri	4,6
Peso gr.	610
Colori di serie*	■
Fondo	chiuso
Pareti lunghe	chiuso
Pareti corte	chiuso
Maniglie	chiuso

05



COD. ART.	DIM. mm
F PC 4851 00 05	400x300x220 h
Dim. esterne mm	400x300x220 h
Dim. interne mm	336x262x187 h
Capacità litri	15,8
Peso gr.	1820
Colori di serie*	■
Fondo	chiuso
Pareti lunghe	chiuso
Pareti corte	chiuso
Maniglie	chiuso

05



COD. ART.	DIM. mm
F PC 6851 00 05	600x400x220 h
Dim. esterne mm	600x400x220 h
Dim. interne mm	535x361x185 h
Capacità litri	34,8
Peso gr.	2880
Colori di serie*	■
Fondo	chiuso
Pareti lunghe	chiuso
Pareti corte	chiuso
Maniglie	chiuso

05



COD. ART.	DIM. mm
F PC 7651 00 05	600x400x320 h
Dim. esterne mm	600x400x320 h
Dim. interne mm	536x361x282 h
Capacità litri	53
Peso gr.	3905
Colori di serie*	■
Fondo	chiuso
Pareti lunghe	chiuso
Pareti corte	chiuso
Maniglie	chiuso



COPERCHIO PER CASSETTE ODETTTE SERIE F PC

05



COD. ART.	DIM. mm
F PC 0351 00 05	300x200
Peso gr.	106
Colori di serie*	■

05



COD. ART.	DIM. mm
F PC 0651 00 05	400x300
Peso gr.	240
Colori di serie*	■

05



COD. ART.	DIM. mm
F PC 0951 00 05	600x400
Peso gr.	500
Colori di serie*	■

■ LEGENDA



Le cassette contrassegnate con questo simbolo sono realizzate in materiale plastico completamente riciclabile.



■ GIALLO
F.....05



SERIE STORAGE ODETTE

■ 05



NEW

Porta etichette per etichetta
dim. 210x105 mm h

COD. ART.

DIM. mm

F PC 9651 00 05 **1000x400x232 h**

Dim. esterne mm 1000x400x232 h

Dim. interne mm 935x355x197 h

Capacità litri 65

Peso gr. 3500

Colori di serie* ■

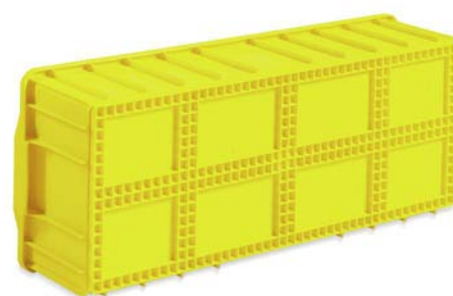
Fondo **chiuso**Pareti lunghe **chiuso**Pareti corte **chiuso**Maniglie **chiuso**■ Particolare del fondo rinforzato delle cassette
art. F PC 9651 00 05

■ *A richiesta disponibili altri colori

GIALLO
F. 05

LEGENDA ■

Le cassette contrassegnate con questo simbolo sono realizzate in
materiale plastico completamente riciclabile.

- OTTIMO RAPPORTO QUALITÀ PREZZO
- INDICATE PER USO ALIMENTARE
- PESO CONTENUTO

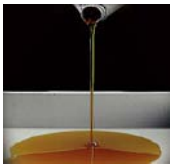

Buona resistenza agli olii



Le cassette marchiate con questo simbolo sono idonee al contatto con alimenti



Robuste e resistente ad alte e basse temperature



■ 01

CASSETTE THEMA SERIE F PA 600x400

- *A richiesta disponibili altri colori



COD. ART.

DIM. mm

F PB 6851 AO 01 600x400x220 h

Dim. esterne mm 600x400x220 h

Dim. interne mm 555x355x203 h

Capacità litri 40

Peso gr. 1960

Colori di serie* ■

Fondo **chiuso**

Pareti lunghe **chiuso**

Pareti corte **chiuso**

Maniglie **chiuso**

Porta etichette: ART. **F PZ 0010 00 99**

Vedi pag. G15



COD. ART.

DIM. mm

F PB 6851 BO 01 600x400x220 h

Dim. esterne mm 600x400x220 h

Dim. interne mm 555x354x203 h

Capacità litri 40

Peso gr. 1950

Colori di serie* ■

Fondo **chiuso**

Pareti lunghe **chiuso**

Pareti corte **chiuso**

Maniglie **aperte**

Porta etichette: ART. **F PZ 0010 00 99**

Vedi pag. G15

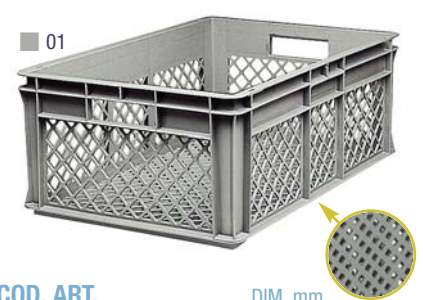

COD. ART.

DIM. mm

F PB 6851 FO 01 600x400x220 h

Dim. esterne mm 600x400x220 h

Dim. interne mm 556x356x200 h

Capacità litri 40

Peso gr. 1475

Colori di serie* ■

Fondo **forato**

Pareti lunghe **forate**

Pareti corte **forate**

Maniglie **aperte**

Porta etichette: ART. **F PZ 0010 00 99**

Vedi pag. G15

■ LEGENDA



Le cassette contrassegnate con questo simbolo sono idonee al contatto con gli alimenti.



Le cassette contrassegnate con questo simbolo sono realizzate in materiale plastico completamente riciclabile.



GRIGIO
F.....01

SERIE STORAGE MINERVA

- MASSIMA RIDUZIONE DEI VOLUMI CON CASSETTA VUOTA
- OTTIMA PER IL TRASPORTO SU STRADA
- OTTIMO RAPPORTO QUALITÀ PREZZO

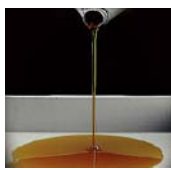

Buona
resistenza
agli olii



Le cassette marchiate
con questo simbolo
sono idonee al contatto
con alimenti



Robuste e resistenti ad alte e basse temperature



■ 01



Le cassette Minerva rispettano le misure unificate europee 600x400 mm e sono pertanto perfettamente palettizzabili.



CARRELLI PER IL TRASPORTO E SOLLEVAMENTO CASSETTE SERIE MINERVA 600x400 mm

COD. ART.

PORTATA kg

F CR 0461 00 04

300

Solo per inforcamento cassette serie Minerva

2 ruote girevoli in gomma Ø 125 mm

2 ruote fisse in poliuretano Ø 125 mm



■ fasi d'impiego
del carrello di
sollevamento



■ 04



GRIGIO
F. 01

RAL 5012 F. 04

LEGENDA ■



Le cassette contrassegnate con questo simbolo sono idonee al contatto con gli alimenti.



Le cassette contrassegnate con questo simbolo sono realizzate in materiale plastico completamente riciclabile.

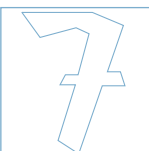

DIMENSIONI = 600x400

SERIE STORAGE MINERVA

CASSETTE SERIE F PE 600x400



COD. ART.

DIM. mm

F PE 6851 BO 01 600x400x200 h

Dim. esterne mm 600x400x200 h

Dim. interne mm 455x338x180 h

Capacità litri 32

Peso gr. 1750

Colori di serie* ■

Fondo **chiuso**Pareti lunghe **chiuso**Pareti corte **chiuso**Maniglie **aperte**

Porta etichette: ART. F PZ 0010 00 99

Vedi pag. G15



COD. ART.

DIM. mm

F PE 6851 FO 01 600x400x200 h

Dim. esterne mm 600x400x200 h

Dim. interne mm 458x338x177 h

Capacità litri 32

Peso gr. 1520

Colori di serie* ■

Fondo **forato**Pareti lunghe **forate**Pareti corte **forate**Maniglie **aperte**

Porta etichette: ART. F PZ 0010 00 99

Vedi pag. G15



COD. ART.

DIM. mm

F PE 7651 BO 01 600x400x300 h

Dim. esterne mm 600x400x300 h

Dim. interne mm 455x338x272 h

Capacità litri 50

Peso gr. 2500

Colori di serie* ■

Fondo **chiuso**Pareti lunghe **chiuso**Pareti corte **chiuso**Maniglie **aperte**

Porta etichette: ART. F PZ 0010 00 99

Vedi pag. G15

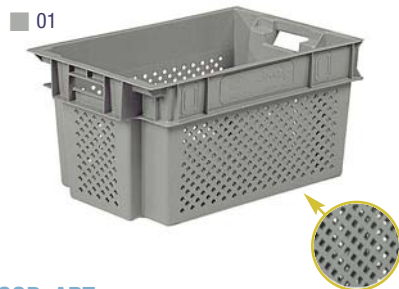

COD. ART.

DIM. mm

F PE 7651 FO 01 600x400x300 h

Dim. esterne mm 600x400x300 h

Dim. interne mm 455x337x270 h

Capacità litri 50

Peso gr. 2320

Colori di serie* ■

Fondo **forato**Pareti lunghe **forate**Pareti corte **forate**Maniglie **aperte**

Porta etichette: ART. F PZ 0010 00 99

Vedi pag. G15



COD. ART.

DIM. mm

F PE 8051 BO 01 600x400x400 h

Dim. esterne mm 600x400x400 h

Dim. interne mm 453x337x370 h

Capacità litri 70

Peso gr. 2940

Colori di serie* ■

Fondo **chiuso**Pareti lunghe **chiuso**Pareti corte **chiuso**Maniglie **aperte**

Porta etichette: ART. F PZ 0010 00 99

Vedi pag. G15



COD. ART.

DIM. mm

F PE 8051 FO 01 600x400x400 h

Dim. esterne mm 600x400x400 h

Dim. interne mm 455x337x372 h

Capacità litri 70

Peso gr. 2865

Colori di serie* ■

Fondo **forato**Pareti lunghe **forate**Pareti corte **forate**Maniglie **aperte**

Porta etichette: ART. F PZ 0010 00 99

Vedi pag. G15

MOLLA A SCATTO PER LA CHIUSURA DEL COPERCHIO



ART. F PZ 0020 00 99

■ 99

COPERCHIO SERIE F PE 600x400



COD. ART.

DIM. mm

F PE 0951 00 01 600x400

Peso gr. 960

Colori di serie* ■

■ *A richiesta disponibili altri colori

■ LEGENDA



Le cassette contrassegnate con questo simbolo sono idonee al contatto con gli alimenti.



Le cassette contrassegnate con questo simbolo sono realizzate in materiale plastico completamente riciclabile.

GRIGIO
F. 01

SERIE STORAGE DELTA

- MASSIMA RIDUZIONE DEI VOLUMI CON CASSETTA VUOTA
- OTTIMA PER IL TRASPORTO SU STRADA
- MASSIMA VERSATILITÀ CON L'UTILIZZO DEL TRAVERSO



- le maniglie chiuse garantiscono una presa facile e sicura anche da mani guantate



- esempio di accatastamento di cassette piene con supporti aperti e accatastamento di cassette con supporti chiusi



- possibilità di chiusura del coperchio con sigillo di sicurezza

- Il supporto (figura 1) viene spinto fino a fine corsa (figura 2) e viene bloccato con una pressione verso il basso (figura 3).

GRIGIO
F. 01

LEGENDA ■



Le cassette contrassegnate con questo simbolo sono idonee al contatto con gli alimenti.



Le cassette contrassegnate con questo simbolo sono realizzate in materiale plastico completamente riciclabile.

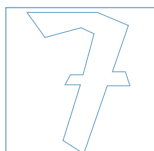

DIMENSIONI = 600x400

SERIE STORAGE DELTA

CASSETTE DELTA F PD 600x400



COD. ART.

DIM. mm

F PD 6851 AO 01 600x400x225 h

Dim. esterne mm 600x400x225 h

Dim. interne mm 499x329x195 h

Capacità litri 38

Peso gr. 1742

Colori di serie* ■

Fondo **chiuso**Pareti lunghe **chiuso**Pareti corte **chiuso**Maniglie **chiuso**

COD. ART.

DIM. mm

F PD 7651 AO 01 600x400x325 h

Dim. esterne mm 600x400x325 h

Dim. interne mm 499x329x295 h

Capacità litri 58

Peso gr. 2332

Colori di serie* ■

Fondo **chiuso**Pareti lunghe **chiuso**Pareti corte **chiuso**Maniglie **chiuso**

COD. ART.

DIM. mm

F PD 8051 AO 01 600x400x425 h

Dim. esterne mm 600x400x425 h

Dim. interne mm 499x329x395 h

Capacità litri 74

Peso gr. 2858

Colori di serie* ■

Fondo **chiuso**Pareti lunghe **chiuso**Pareti corte **chiuso**Maniglie **chiuso**

COD. ART.

DIM. mm

F PD 6851 AB 01 600x400x230 h

Dim. esterne mm 600x400x230 h

Dim. interne mm 499x329x195 h

Capacità litri 38

Peso gr. 1930

Colori di serie* ■

Fondo **chiuso**Pareti lunghe **chiuso**Pareti corte **chiuso**Maniglie **chiuso**

Completo di supporti per l'accatastamento



COD. ART.

DIM. mm

F PD 7651 AB 01 600x400x330 h

Dim. esterne mm 600x400x330 h

Dim. interne mm 499x329x295 h

Capacità litri 58

Peso gr. 2524

Colori di serie* ■

Fondo **chiuso**Pareti lunghe **chiuso**Pareti corte **chiuso**Maniglie **chiuso**

Completo di supporti per l'accatastamento



COD. ART.

DIM. mm

F PD 8051 AB 01 600x400x430 h

Dim. esterne mm 600x400x430 h

Dim. interne mm 499x329x395 h

Capacità litri 74

Peso gr. 3055

Colori di serie* ■

Fondo **chiuso**Pareti lunghe **chiuso**Pareti corte **chiuso**Maniglie **chiuso**

Completo di supporti per l'accatastamento



COD. ART.

DIM. mm

F PD 6851 AA 01 610x400x240 h

Dim. esterne mm 610x400x240 h

Dim. interne mm 499x329x195 h

Capacità litri 38

Peso gr. 2640

Colori di serie* ■

Fondo **chiuso**Pareti lunghe **chiuso**Pareti corte **chiuso**Maniglie **chiuso**

Completo di coperchio a cerniera



COD. ART.

DIM. mm

F PD 7651 AA 01 610x400x340 h

Dim. esterne mm 610x400x340 h

Dim. interne mm 499x329x295 h

Capacità litri 58

Peso gr. 3230

Colori di serie* ■

Fondo **chiuso**Pareti lunghe **chiuso**Pareti corte **chiuso**Maniglie **chiuso**

Completo di coperchio a cerniera



COD. ART.

DIM. mm

F PD 8051 AA 01 610x400x440 h

Dim. esterne mm 610x400x440 h

Dim. interne mm 499x329x395 h

Capacità litri 74

Peso gr. 3765

Colori di serie* ■

Fondo **chiuso**Pareti lunghe **chiuso**Pareti corte **chiuso**Maniglie **chiuso**

Completo di coperchio a cerniera

SERIE STORAGE NETTUNO

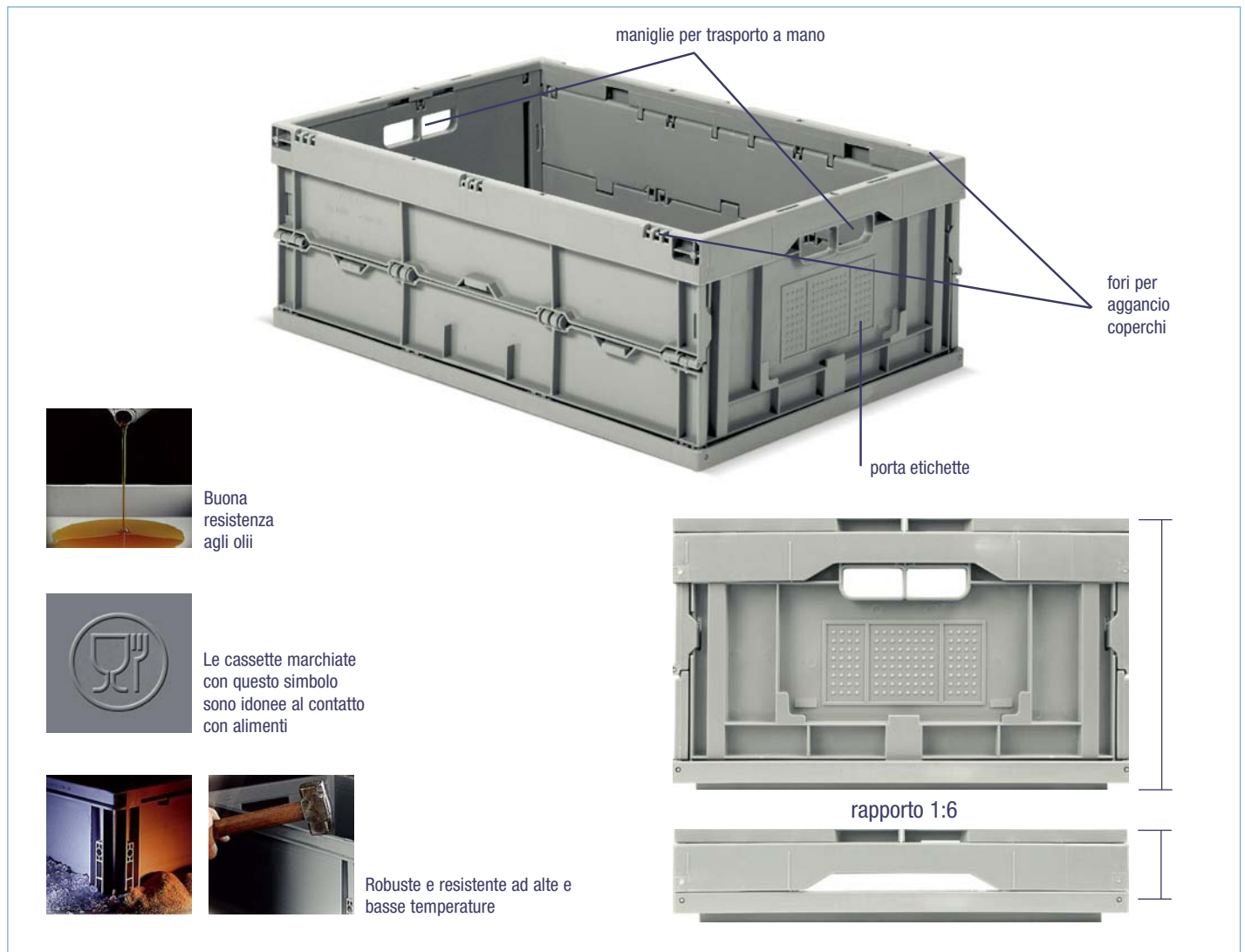

CASSETTE NETTUNO SERIE F PF 400x300

- Porta etichette: ART. F PZ 9551 00 07
Vedi pagina G15

- *A richiesta disponibili altri colori

■ 01

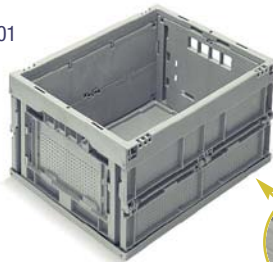

■ 01



- Completa di coperchio a cerniera

COD. ART.

DIM. mm

COD. ART.	DIM. mm
F PF 4851 BB 01	400x300x220 h
Dim. esterne mm	400x300x220 h
Dim. chiusa mm	400x300x70 h
Capacità litri	22
Peso gr.	1308
Colori di serie*	■
Fondo	chiuso
Pareti lunghe	chiuso
Pareti corte	chiuso
Maniglie	aperte

COD. ART.

DIM. mm

COD. ART.	DIM. mm
F PF 4851 BA 01	400x300x230 h
Dim. esterne mm	400x300x230 h
Dim. chiusa mm	400x300x85 h
Capacità litri	22
Peso gr.	1654
Colori di serie*	■
Fondo	chiuso
Pareti lunghe	chiuso
Pareti corte	chiuso
Maniglie	aperte

GRIGIO
F. 01

LEGENDA ■



Le cassette contrassegnate con questo simbolo sono idonee al contatto con gli alimenti.



Le cassette contrassegnate con questo simbolo sono realizzate in materiale plastico completamente riciclabile.

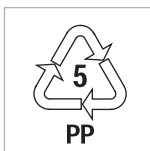
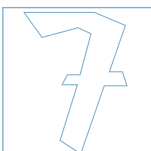

DIMENSIONI = 600x400

SERIE STORAGE NETTUNO

CASSETTE NETTUNO SERIE F PF 600x400

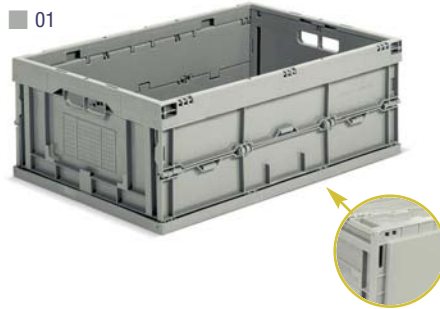

■ Completa di coperchio a cerniera

- Porta etichette: ART. F PZ 9751 00 07
Vedi pagina G15

- *A richiesta disponibili altri colori

COD. ART.	DIM. mm
F PF 6851 BB 01	600x400x220 h
Dim. esterne mm	600x400x220 h
Dim. chiusa mm	600x400x68 h
Capacità litri	45
Peso gr.	2170
Colori di serie*	■
Fondo	chiuso
Pareti lunghe	chiuse
Pareti corte	chiuse
Maniglie	aperte

COD. ART.	DIM. mm
F PF 6851 BA 01	600x400x230 h
Dim. esterne mm	600x400x230 h
Dim. chiusa mm	600x400x80 h
Capacità litri	45
Peso gr.	2870
Colori di serie*	■
Fondo	chiuso
Pareti lunghe	chiuse
Pareti corte	chiuse
Maniglie	aperte

CASSETTE NETTUNO SERIE F PF 600x400

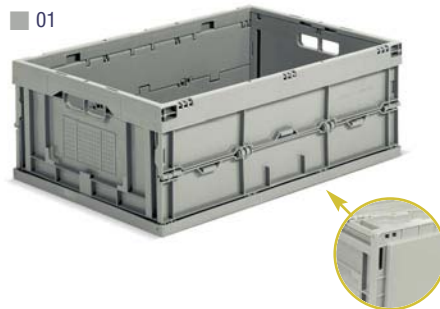

■ Completa di coperchio a cerniera

- Porta etichette: ART. F PZ 9751 00 07
Vedi pagina G15

- *A richiesta disponibili altri colori

COD. ART.	DIM. mm
F PF 7651 BB 01	600x400x320 h
Dim. esterne mm	600x400x320 h
Dim. chiusa mm	600x400x70 h
Capacità litri	65
Peso gr.	2642
Colori di serie*	■
Fondo	chiuso
Pareti lunghe	chiuse
Pareti corte	chiuse
Maniglie	aperte

COD. ART.	DIM. mm
F PF 7651 BA 01	600x400x330 h
Dim. esterne mm	600x400x330 h
Dim. chiusa mm	600x400x82 h
Capacità litri	65
Peso gr.	3338
Colori di serie*	■
Fondo	chiuso
Pareti lunghe	chiuse
Pareti corte	chiuse
Maniglie	aperte

■ LEGENDA



Le cassette contrassegnate con questo simbolo sono idonee al contatto con gli alimenti.



Le cassette contrassegnate con questo simbolo sono realizzate in materiale plastico completamente riciclabile.



GRIGIO
F. 01

SERIE STORAGE ZEUS

- RESISTENTI AGLI URTI
- DISPONIBILI IN 5 COLORI
- ROBUSTO BORDO PER LA SOVRAPPOSIZIONE

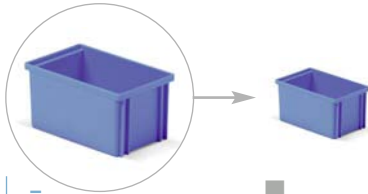

-	■
-	■
-	■
-	■
-	■
Cod. Art. F PJ 0151 00 04	■
-	■
Dim. esterne mm	145x90x70 h
Dim. interne mm	123x80x63 h
Capacità litri	0,9
Peso gr.	70

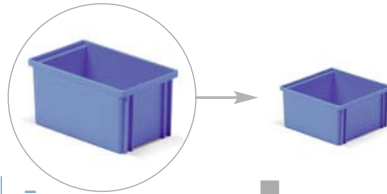

-	■
-	■
-	■
-	■
-	■
Cod. Art. F PJ 1751 00 04	■
-	■
Dim. esterne mm	145x140x70 h
Dim. interne mm	127x123x63 h
Capacità litri	1,4
Peso gr.	90

**misura 272-2**

Cod. Art. F PJ 2551 00 01	■
Cod. Art. F PJ 2551 00 02	■
Cod. Art. F PJ 2551 00 03	■
Cod. Art. F PJ 2551 00 04	■
Cod. Art. F PJ 2551 00 05	■
Dim. esterne mm	200x140x130 h
Dim. interne mm	186x125x110 h
Capacità litri	3,6
Peso gr.	265

**misura 272-3A2**

Cod. Art. F PJ 3351 00 01	■
Cod. Art. F PJ 3351 00 02	■
Cod. Art. F PJ 3351 00 03	■
Cod. Art. F PJ 3351 00 04	■
Cod. Art. F PJ 3351 00 05	■
Dim. esterne mm	300x200x145 h
Dim. interne mm	284x181x130 h
Capacità litri	8,7
Peso gr.	525

**misura 272-4A2**

Cod. Art. F PJ 5751 00 01	■
Cod. Art. F PJ 5751 00 02	■
Cod. Art. F PJ 5751 00 03	■
Cod. Art. F PJ 5751 00 04	■
Cod. Art. F PJ 5751 00 05	■
Dim. esterne mm	450x300x120 h
Dim. interne mm	426x275x106 h
Capacità litri	16,2
Peso gr.	1000

**misura 272-4**

Cod. Art. F PJ 6551 00 01	■
Cod. Art. F PJ 6551 00 02	■
Cod. Art. F PJ 6551 00 03	■
Cod. Art. F PJ 6551 00 04	■
Cod. Art. F PJ 6551 00 05	■
Dim. esterne mm	450x300x200 h
Dim. interne mm	428x277x183 h
Capacità litri	27
Peso gr.	1370

**misura 272-4A5**

Cod. Art. F PJ 7351 00 01	■
Cod. Art. F PJ 7351 00 02	■
Cod. Art. F PJ 7351 00 03	■
Cod. Art. F PJ 7351 00 04	■
Cod. Art. F PJ 7351 00 05	■
Dim. esterne mm	450x300x300 h
Dim. interne mm	426x277x286 h
Capacità litri	40,5
Peso gr.	1865

**misura 272-5**

Cod. Art. F PJ 8951 00 01	■
Cod. Art. F PJ 8951 00 02	■
Cod. Art. F PJ 8951 00 03	■
Cod. Art. F PJ 8951 00 04	■
Cod. Art. F PJ 8951 00 05	■
Dim. esterne mm	630x450x300 h
Dim. interne mm	605x428x275 h
Capacità litri	85
Peso gr.	4390

GRIGIO F.01 VERDE F.02 ROSSO F.03 BLU F.04 GIALLO F.05

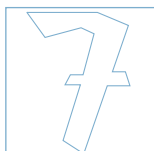
LEGENDA ■

Le cassette contrassegnate con questo simbolo sono idonee al contatto con gli alimenti.



Le cassette contrassegnate con questo simbolo sono realizzate in materiale plastico completamente riciclabile.



MISURE = 01 / 0 / 1 / 2 / 3A2 / 3

SERIE STORAGE ZEUS - COMPAT



presa con maniglia e traversino di sollevamento

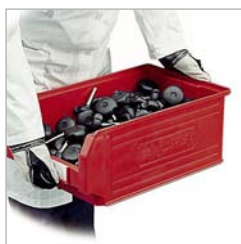

presa con maniglia

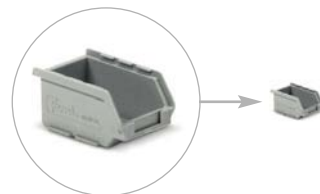
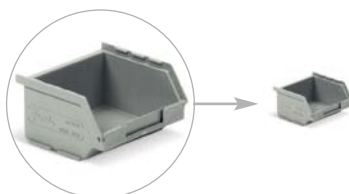

- RESISTENTI AGLI URTI
- DISPONIBILI IN 5 COLORI
- ROBUSTO BORDO PER LA SOVRAPPOSIZIONE

misura 01

Cod. Art. F PL 0151 00 01	■
Cod. Art. F PL 0151 00 02	■
Cod. Art. F PL 0151 00 03	■
Cod. Art. F PL 0151 00 04	■
Cod. Art. F PL 0151 00 05	■
Dim. esterne mm	72/60x45x32 h
Dim. interne mm	55x38x32 h
Capacità litri	0,08
Peso gr.	18



misura 0

Cod. Art. F PL 0951 00 01	■
Cod. Art. F PL 0951 00 02	■
Cod. Art. F PL 0951 00 03	■
Cod. Art. F PL 0951 00 04	■
Cod. Art. F PL 0951 00 05	■
Dim. esterne mm	85/65x95x45 h
Dim. interne mm	63x90x43 h
Capacità litri	0,25
Peso gr.	40

misura 1

Cod. Art. F PM 1751 00 01	■
Cod. Art. F PM 1751 00 02	■
Cod. Art. F PM 1751 00 03	■
Cod. Art. F PM 1751 00 04	■
Cod. Art. F PM 1751 00 05	■
Dim. esterne mm	160/140x95x75 h
Dim. interne mm	134x88x65 h
Capacità litri	1
Peso gr.	100



misura 2

Cod. Art. F PM 2551 00 01	■
Cod. Art. F PM 2551 00 02	■
Cod. Art. F PM 2551 00 03	■
Cod. Art. F PM 2551 00 04	■
Cod. Art. F PM 2551 00 05	■
Dim. esterne mm	230/200x140x130 h
Dim. interne mm	190x124x111 h
Capacità litri	3,8
Peso gr.	280



misura 3A2

Cod. Art. F PM 3351 00 01	■
Cod. Art. F PM 3351 00 02	■
Cod. Art. F PM 3351 00 03	■
Cod. Art. F PM 3351 00 04	■
Cod. Art. F PM 3351 00 05	■
Dim. esterne mm	350/300x200x145 h
Dim. interne mm	285x182x130 h
Capacità litri	9,4
Peso gr.	585



misura 3

Cod. Art. F PM 4151 00 01	■
Cod. Art. F PM 4151 00 02	■
Cod. Art. F PM 4151 00 03	■
Cod. Art. F PM 4151 00 04	■
Cod. Art. F PM 4151 00 05	■
Dim. esterne mm	350/300x200x200 h
Dim. interne mm	278x180x187 h
Capacità litri	12,5
Peso gr.	735

■ LEGENDA

- GRIGIO F. 01
- VERDE F. 02
- ROSSO F. 03
- BLU F. 04
- GIALLO F. 05



I contenitori contrassegnati con questo simbolo sono idonei al contatto con gli alimenti.



Le cassette contrassegnate con questo simbolo sono realizzate in materiale plastico completamente riciclabile.



SERIE STORAGE ZEUS - COMPAT

**misura 3L5**

Cod. Art. F PL 4951 00 01 ■

Cod. Art. F PL 4951 00 02 ■

Cod. Art. F PL 4951 00 03 ■

Cod. Art. F PL 4951 00 04 ■

Cod. Art. F PL 4951 00 05 ■

Dim. esterne mm 350/300x450x145 h

Dim. interne mm 294x432x131 h

Capacità litri 19

Peso gr. 1060

**misura 4A2**

Cod. Art. F PM 5751 00 01 ■

Cod. Art. F PM 5751 00 02 ■

Cod. Art. F PM 5751 00 03 ■

Cod. Art. F PM 5751 00 04 ■

Cod. Art. F PM 5751 00 05 ■

Dim. esterne mm 500/450x300x145 h

Dim. interne mm 440x278x129 h

Capacità litri 20

Peso gr. 1215

**misura 4**

Cod. Art. F PM 6551 00 01 ■

Cod. Art. F PM 6551 00 02 ■

Cod. Art. F PM 6551 00 03 ■

Cod. Art. F PM 6551 00 04 ■

Cod. Art. F PM 6551 00 05 ■

Dim. esterne mm 500/450x300x200 h

Dim. interne mm 435x281x186 h

Capacità litri 28

Peso gr. 1355

**misura 4A5**

Cod. Art. F PM 7351 00 01 ■

Cod. Art. F PM 7351 00 02 ■

Cod. Art. F PM 7351 00 03 ■

Cod. Art. F PM 7351 00 04 ■

Cod. Art. F PM 7351 00 05 ■

Dim. esterne mm 500/450x300x300 h

Dim. interne mm 432x280x287 h

Capacità litri 42

Peso gr. 1925

**misura 5P4**

Cod. Art. F PL 8151 00 01 ■

Cod. Art. F PL 8151 00 02 ■

Cod. Art. F PL 8151 00 03 ■

Cod. Art. F PL 8151 00 04 ■

Cod. Art. F PL 8151 00 05 ■

Dim. esterne mm 520/450x450x300 h

Dim. interne mm 431x430x277 h

Capacità litri 63

Peso gr. 3485

**misura 5**

Cod. Art. F PL 8951 00 01 ■

Cod. Art. F PL 8951 00 02 ■

Cod. Art. F PL 8951 00 03 ■

Cod. Art. F PL 8951 00 04 ■

Cod. Art. F PL 8951 00 05 ■

Dim. esterne mm 700/630x450x300 h

Dim. interne mm 615x427x275 h

Capacità litri 88

Peso gr. 4330

GRIGIO F.01 ■ VERDE F.02 ■ ROSSO F.03 ■ BLU F.04 ■ GIALLO F.05 ■

LEGENDA ■

I contenitori contrassegnati con questo simbolo sono idonei al contatto con gli alimenti.



Le cassette contrassegnate con questo simbolo sono realizzate in materiale plastico completamente riciclabile.



CASSETTE DIVISORIO



- Cod. Art. F PJ 2551 00 01 ■
- Cod. Art. F PJ 2551 00 02 ■
- Cod. Art. F PJ 2551 00 03 ■
- Cod. Art. F PJ 2551 00 04 ■
- Cod. Art. F PJ 2551 00 05 ■

Dim. esterne mm	200x140x130 h
N. cassette divisorio inseribili	6 per ART. F PL 8151 00 .. 8 per ART. F PL 8951 00 ..



CASSETTE DIVISORIO A 2/4 SCOMPARTI PER CONTENITORI SERIE F PM

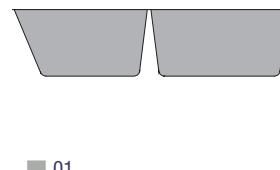
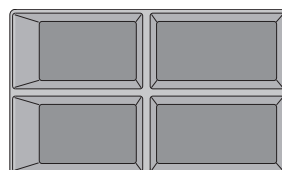
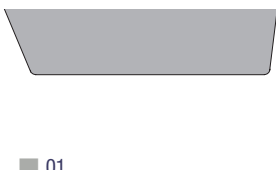
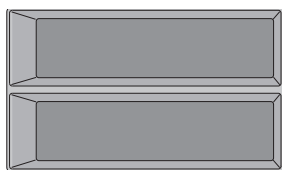

Cassetta divisorio a 2 scomparti

COD. ART.

F PP 0551 00 01

Dim. esterne mm	150/120x90x35 h
Numero scomparti	2
Per contenitori ART.	F PM 1751 00 ..



Cassetta divisorio a 4 scomparti

COD. ART.

F PP 1051 00 01

Dim. esterne mm	150/120x90x35 h
Numero scomparti	4
Per contenitori ART.	F PM 1751 00 ..

COD. ART.

F PP 1551 00 01

Dim. esterne mm	205/160x125x60 h
Numero scomparti	2
Per contenitori ART.	F PM 2551 00 ..



COD. ART.

F PP 2051 00 01

Dim. esterne mm	205/160x125x60 h
Numero scomparti	4
Per contenitori ART.	F PM 2551 00 ..

■ LEGENDA

- GRIGIO
F.01
- VERDE
F.02
- ROSSO
F.03
- BLU
F.04
- GIALLO
F.05



Le cassette contrassegnate con questo simbolo sono idonee al contatto con gli alimenti.



Le cassette contrassegnate con questo simbolo sono realizzate in materiale plastico completamente riciclabile.



SERIE STORAGE ZEUS – COMPAT

DIVISORIO LONGITUDINALE IN METALLO PER CONTENITORI SERIE F PL – F PM



■ 99

Divisorio longitudinale in metallo con coppia supporti

COD. ART. F ND 0211 01 99

Per contenitori ART. F PL 8151 00 ..

COD. ART. F ND 0231 01 99

Per contenitori ART. F PL 8951 00 ..



Divisorio longitudinale supplementare

COD. ART. F ND 0211 00 99

Per contenitori ART. F PL 8151 00 ..

COD. ART. F ND 0231 00 99

Per contenitori ART. F PL 8951 00 ..



■ 99

Divisorio longitudinale in metallo

COD. ART. F ND 0110 00 99

Per contenitori ART. F PM 3351 00 ..

COD. ART. F ND 0140 00 99

Per contenitori ART. F PM 4151 00 ..

COD. ART. F ND 0150 00 99

Per contenitori ART. F PL 4951 00 ..

COD. ART. F ND 0160 00 99

Per contenitori ART. F PM 5751 00 ..

COD. ART. F ND 0180 00 99

Per contenitori ART. F PM 6551 00 ..

COD. ART. F ND 0170 00 99

Per contenitori ART. F PM 7351 00 ..

DIVISORIO TRASVERSALE PER CONTENITORI SERIE F PM



Divisorio trasversale

COD. ART. F ND 1110 00 99

Per contenitori ART. F PM 6551 00 ..

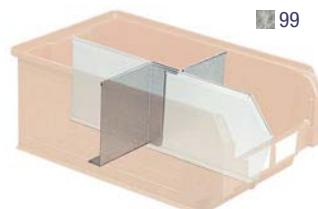

■ 99

DIVISORIO LONGITUDINALE IN PLASTICA PER CONTENITORI SERIE F PL – F PM

Divisorio longitudinale in plastica

COD. ART. F PZ 1071 00 07

Per contenitori ART. F PM 3351 00 ..

COD. ART. F PZ 1571 00 07

Per contenitori ART. F PM 4151 00 ..

COD. ART. F PZ 2071 00 07

Per contenitori ART. F PL 4951 00 ..

COD. ART. F PZ 2571 00 07

Per contenitori ART. F PM 6551 00 ..

COD. ART. F PZ 3071 00 07

Per contenitori ART. F PM 7351 00 ..

■ 07



**GARANZIA
5
ANNI**



ZINCATO
F. 99

NERO
F. 07

INFO ■





ART. F ND 2110 00 99



ART. F ND 2130 00 99

PORTA ETICHETTE INCLINATO

COD. ART.	PER CONTENITORI ART.
F ND 2110 00 99	F PM 3351 00 ..
	F PM 4151 00 ..
	F PM 4251 00 ..
	F PM 6551 00 ..
	F PM 6651 00 ..
	F PM 7351 00 ..
	F PM 7451 00 ..
F ND 2130 00 99	F PL 8151 00 ..
	F PL 8951 00 ..



ETICHETTE PER CONTENITORI E CASSETTE

COD. ART.	PER CASSETTE E CONTENITORI ART.	DIM. ETICHETTA SINGOLA mm	N. ETICHETTE PER FOGLIO
F PL 9020 00 00	F PL 0951 00 ..	49x11	80
F PL 9040 00 00	F PM 1751 00 ..	75x20	36
F PL 9100 00 00	F PM 2551 00 ..	104x33	16
F PL 9060 00 00	F PM 3351 00 ..	77x31	18
	F PL 4951 00 ..		
	F PM 5751 00 ..		
F PL 9080 00 00	F PM 4151 00 ..	77x42	12
	F PM 4251 00 ..		
	F PM 6551 00 ..		
	F PM 6651 00 ..		
	F PM 7351 00 ..		
F PL 9120 00 00	F PM 7451 00 ..	127x39	10
	F PL 8151 00 ..		
	F PL 8951 00 ..		
F PL 9160 00 00	F PL 8151 00 ..	189x85	3
	F PL 8951 00 ..		
	F PJ 6551 00 ..		
	F PJ 7351 00 ..		
F PL 9140 00 00	F PJ 8951 00 ..	189x82	3
	F PJ 5751 00 ..		



MARCHIATURA PERSONALIZZATA



marchiatura a rilievo

loghi marchiati a caldo



MASCHERINE PARAPOLVERE PER CONTENITORI SERIE F PM



COD. ART.	PER CONTENITORI ART.
F PZ 5668 00 96	F PM 3351 00 ..
F PZ 5368 00 96	F PM 4151 00 .. / F PM 4251 00 ..
F PZ 6568 00 96	F PM 6551 00 .. / F PM 6651 00 ..
F PZ 6268 00 96	F PM 7351 00 .. / F PM 7451 00 ..

INFO

ZINCATO F. 99

TRASPARENTE F. 96



www.famispa.com



SERIE STORAGE STEEL



- MANIGLIA A BLOCCO PERPENDICOLARE
- DISPONIBILI IN DUE COLORI E ZINCATO
- FACILITÀ DI TRASPORTO CON CARRELLO



Maniglia a blocco perpendicolare



Cassetta verniciata

CARRELLI PER IL TRASPORTO E SOLLEVAMENTO CASSETTE IN METALLO SERIE F LA

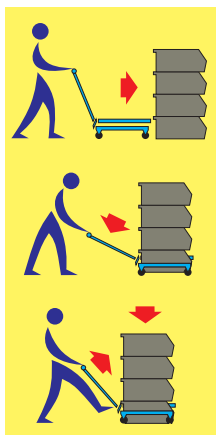

fasi d'impiego del carrello di sollevamento



COD. ART.	PORTATA kg
F CR 0401 00 04	300
Carrello per contenitori e cassette	
ART. F LS 6500 00 .. / ART. F LA 6520 00 ..	
2 ruote girevoli in gomma Ø 125 mm	
2 ruote fisse in poliuretano Ø 125 mm	

- N.B. Anche i contenitori e le cassette in plastica possono essere trasportati con questo carrello, facendo però attenzione che il primo contenitore o cassetta inforcati siano in metallo.



COD. ART.	PORTATA kg
F CR 0421 00 04	300
Carrello per contenitori e cassette	
ART. F LS 8900 00 .. / ART. F LS 8100 00 .. / ART. F LA 8920 00 ..	
2 ruote girevoli in gomma Ø 125 mm	
2 ruote fisse in poliuretano Ø 125 mm	

RAL 5012
F.04RAL 7000
F.01ZINCATO a caldo
F.99

INFO ■

www.famispa.com

CASSETTE IN METALLO

SERIE STORAGE STEEL

**misura 272-3A2**

Cod. Art. F LA 3320 00 01 ■

Cod. Art. F LA 3320 00 02 ■

Cod. Art. F LA 3320 00 99 ■

Dim. esterne mm 300x200x145 h

Dim. interne mm 290x183x132 h

Capacità litri 8,7

**misura 272-3**

Cod. Art. F LA 4120 00 01 ■

Cod. Art. F LA 4120 00 02 ■

Cod. Art. F LA 4120 00 99 ■

Dim. esterne mm 300x200x200 h

Dim. interne mm 290x186x184 h

Capacità litri 12

**misura 272-4**

Cod. Art. F LA 6520 00 01 ■

Cod. Art. F LA 6520 00 02 ■

Cod. Art. F LA 6520 00 99 ■

Dim. esterne mm 450x300x200 h

Dim. interne mm 442x285x182 h

Capacità litri 27

**misura 272-4A5**

Cod. Art. F LA 7320 00 01 ■

Cod. Art. F LA 7320 00 02 ■

Cod. Art. F LA 7320 00 99 ■

Dim. esterne mm 450x300x300 h

Dim. interne mm 440x280x278 h

Capacità litri 40,5

**misura 272-5**

Cod. Art. F LA 8920 00 01 ■

Cod. Art. F LA 8920 00 02 ■

Cod. Art. F LA 8920 00 99 ■

Dim. esterne mm 630x450x300 h

Dim. interne mm 617x430x278 h

Capacità litri 85

**ETICHETTE PER
CONTENITORI E CASSETTE**

COD. ART.	PER CASSETTE E CONTENITORI ART.	DIM. ETICHETTA SINGOLA mm	N. ETICHETTE PER FOGLIO
F LS 9040 00 00	F LA 3320 00 ..	73x37	15
F LS 9060 00 00	F LA 4120 00 .. F LA 6520 00 ..	80x48	12
F LS 9080 00 00	F LA 7320 00 .. F LA 8920 00 ..	102x76	6

■ INFO

RAL 6011
F.02RAL 7000
F.01ZINCATO a caldo
F.99

www.famispa.com



SERIE STORAGE STEEL

- MANIGLIA A BLOCCO PERPENDICOLARE
- IDEALI PER IL LAVAGGIO DEL LORO CONTENUTO
- FORI DI SEI DIAMETRI DIVERSI
- IN ACCIAIO INOX E ZINCATO A CALDO



Le cassette forate FAMI sono state realizzate per soddisfare l'esigenza di lavare il contenuto senza estrarlo. Per questa loro caratteristica sono particolarmente impiegate nelle lavorazioni come la sgrassatura di componenti destinate all'assemblaggio dove è necessario eliminare i liquidi di lavaggio. Inoltre favoriscono, se necessario, un'ottima areazione del prodotto.

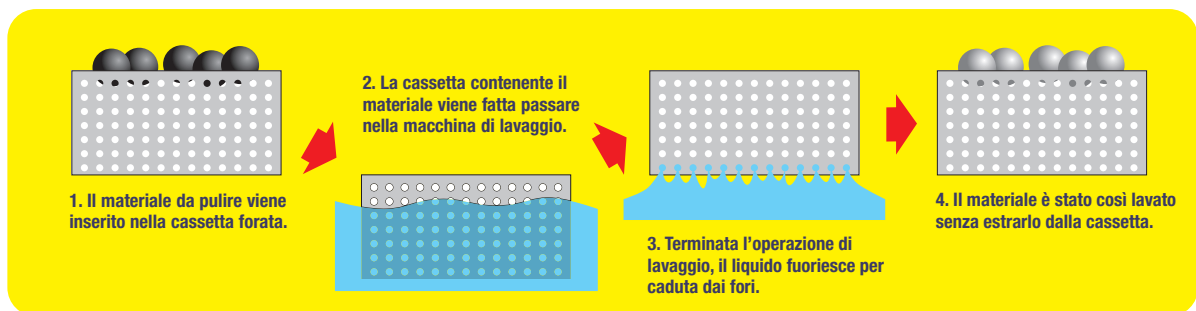
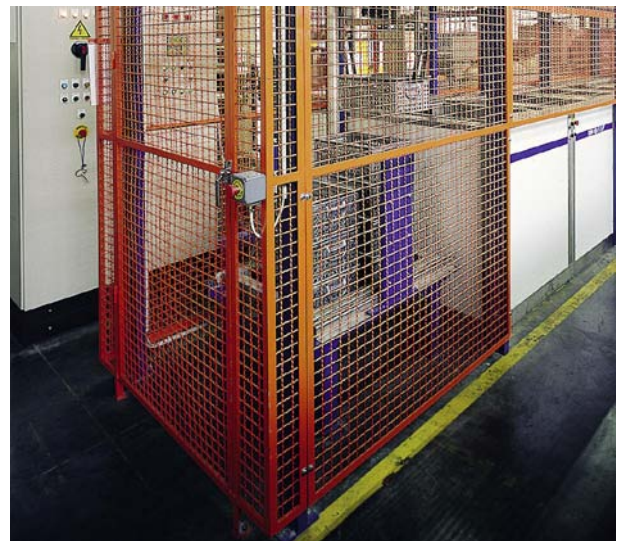

ACCIAIO
F.ZZ

ZINCATO a caldo
F.99

INFO ■

www.famispa.com



CASSETTE FORATE

SERIE STORAGE STEEL

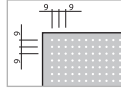

foro Ø 3 mm

**misura 272-4****Cod. Art. F LA 6510 00 ZZ**

Dim. esterne mm 450x300x200 h

Dim. interne mm 442x285x182 h

Capacità litri 27

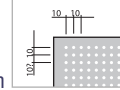

foro Ø 4,2 mm

**misura 272-4****Cod. Art. F LA 6511 00 99**

Dim. esterne mm 450x300x200 h

Dim. interne mm 442x285x182 h

Capacità litri 27

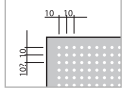

foro Ø 5,5 mm

**misura 272-4****Cod. Art. F LA 6512 00 99**

Dim. esterne mm 450x300x200 h

Dim. interne mm 442x285x182 h

Capacità litri 27

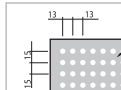

foro Ø 7 mm

**misura 272-4****Cod. Art. F LA 6513 00 99**

Dim. esterne mm 450x300x200 h

Dim. interne mm 442x285x182 h

Capacità litri 27

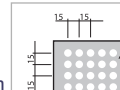

foro Ø 10 mm

**misura 272-4****Cod. Art. F LA 6515 00 99**

Dim. esterne mm 450x300x200 h

Dim. interne mm 442x285x182 h

Capacità litri 27

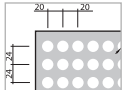

foro Ø 15 mm

**misura 272-4****Cod. Art. F LA 6517 00 99**

Dim. esterne mm 450x300x200 h

Dim. interne mm 442x285x182 h

Capacità litri 27

■ INFO

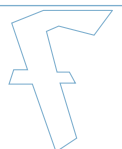
ACCAIO
F.ZZZINCATO a caldo
F.99
www.famispa.com

SERIE STORAGE STEEL

- MANIGLIA A BLOCCO PERPENDICOLARE
- NUMEROSI MODELLI PER OGNI NECESSITÀ
- IN LAMIERA D'ACCIAIO VERNICIATA O ZINCATA
- L'APERTURA FRONTALE FACILITA IL PRELIEVO DEL MATERIALE



CONTENITORI CON APPLICAZIONI SPECIALI

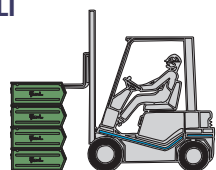

sistema di prelievo con
carrello elevatore

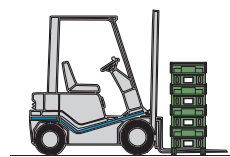

sistema di prelievo con
carrello elevatore

RAL 6011
F. 02

RAL 7000
F. 01

ZINCATO a caldo
F. 99

INFO ■

www.famispa.com



CONTENITORI IN METALLO

SERIE STORAGE STEEL



traversino di sollevamento
abbinato alla maniglia a blocco
perpendicolare

**misura 1**

Cod. Art. F LS 1700 00 01 ■

Cod. Art. F LS 1700 00 02 ■

Cod. Art. F LS 1700 00 99 ■

Dim. esterne mm 160/140x95x75 h

Dim. interne mm 138x86x66 h

Capacità litri 1

Senza maniglia a blocco perpendicolare

**misura 2**

Cod. Art. F LS 2500 00 01 ■

Cod. Art. F LS 2500 00 02 ■

Cod. Art. F LS 2500 00 99 ■

Dim. esterne mm 230/200x140x130 h

Dim. interne mm 196x131x113 h

Capacità litri 3,8

Senza maniglia a blocco perpendicolare

**misura 3A2**

Cod. Art. F LS 3300 00 01 ■

Cod. Art. F LS 3300 00 02 ■

Cod. Art. F LS 3300 00 99 ■

Dim. esterne mm 350/300x200x145 h

Dim. interne mm 298x181x135 h

Capacità litri 9,4

Senza maniglia a blocco perpendicolare

**misura 3**

Cod. Art. F LS 4100 00 01 ■

Cod. Art. F LS 4100 00 02 ■

Cod. Art. F LS 4100 00 99 ■

Dim. esterne mm 350/300x200x200 h

Dim. interne mm 300x185x184 h

Capacità litri 12,5

Con maniglia a blocco perpendicolare

**misura 3P4**

Cod. Art. F LS 4900 00 01 ■

Cod. Art. F LS 4900 00 02 ■

Cod. Art. F LS 4900 00 99 ■

Dim. esterne mm 500/450x200x200 h

Dim. interne mm 448x184x184 h

Capacità litri 18

Con maniglia a blocco perpendicolare

**misura 4A2**

Cod. Art. F LS 5700 00 01 ■

Cod. Art. F LS 5700 00 02 ■

Cod. Art. F LS 5700 00 99 ■

Dim. esterne mm 500/450x300x145 h

Dim. interne mm 448x281x135 h

Capacità litri 20

Senza maniglia a blocco perpendicolare

**misura 4**

Cod. Art. F LS 6500 00 01 ■

Cod. Art. F LS 6500 00 02 ■

Cod. Art. F LS 6500 00 99 ■

Dim. esterne mm 500/450x300x200 h

Dim. interne mm 448x284x185 h

Capacità litri 28

Con maniglia a blocco perpendicolare

**misura 4A5**

Cod. Art. F LS 7300 00 01 ■

Cod. Art. F LS 7300 00 02 ■

Cod. Art. F LS 7300 00 99 ■

Dim. esterne mm 520/450x300x300 h

Dim. interne mm 446x288x278 h

Capacità litri 42

Con maniglia a blocco perpendicolare

**misura 5P4**

Cod. Art. F LS 8100 00 01 ■

Cod. Art. F LS 8100 00 02 ■

Cod. Art. F LS 8100 00 99 ■

Dim. esterne mm 520/450x450x300 h

Dim. interne mm 448x428x278 h

Capacità litri 63

Con maniglia a blocco perpendicolare

**misura 5**

Cod. Art. F LS 8900 00 01 ■

Cod. Art. F LS 8900 00 02 ■

Cod. Art. F LS 8900 00 99 ■

Dim. esterne mm 700/630x450x300 h

Dim. interne mm 630x428x278 h

Capacità litri 88

Con maniglia a blocco perpendicolare

■ INFO

RAL 6011
F.02RAL 7000
F.01ZINCATO a caldo
F.99
www.famispa.com

SERIE STORAGE STEEL

CONTENITORI CON DOPPIO TRAVERSINO

**misura 4**

Cod. Art. F LS 6501 00 01 ■

Cod. Art. F LS 6501 00 02 ■

Cod. Art. F LS 6501 00 99 ■

Dim. esterne mm 500/450x300x200 h

Dim. interne mm 448x284x185 h

Capacità litri 28

Con maniglia a blocco perpendicolare

**misura 4A5**

Cod. Art. F LS 7301 00 01 ■

Cod. Art. F LS 7301 00 02 ■

Cod. Art. F LS 7301 00 99 ■

Dim. esterne mm 520/450x300x300 h

Dim. interne mm 446x288x278 h

Capacità litri 42

Con maniglia a blocco perpendicolare

**misura 5P4**

Cod. Art. F LS 8101 00 01 ■

Cod. Art. F LS 8101 00 02 ■

Cod. Art. F LS 8101 00 99 ■

Dim. esterne mm 520/450x450x300 h

Dim. interne mm 448x428x278 h

Capacità litri 63

Con maniglia a blocco perpendicolare

**misura 5**

Cod. Art. F LS 8901 00 01 ■

Cod. Art. F LS 8901 00 02 ■

Cod. Art. F LS 8901 00 99 ■

Dim. esterne mm 700/630x450x300 h

Dim. interne mm 630x428x278 h

Capacità litri 88

Con maniglia a blocco perpendicolare



CONTENITORI CON SLITTA

**misura 5P4**

Cod. Art. F LS 8110 00 01 ■

Cod. Art. F LS 8110 00 02 ■

Cod. Art. F LS 8110 00 99 ■

Dim. esterne mm 520/450x450x390 h

Dim. interne mm 448x428x278 h

Capacità litri 63

Con maniglia a blocco perpendicolare

**misura 5**

Cod. Art. F LS 8910 00 01 ■

Cod. Art. F LS 8910 00 02 ■

Cod. Art. F LS 8910 00 99 ■

Dim. esterne mm 700/630x450x390 h

Dim. interne mm 630x428x278 h

Capacità litri 88

Con maniglia a blocco perpendicolare

RAL 6011
F.02RAL 7000
F.01ZINCATO a caldo
F.99

INFO ■

www.famispa.com



ETICHETTE / DIVISORI LONGITUDINALI IN METALLO



ART. F ND 2120 00 99



ART. F ND 2110 00 99

PORTA ETICHETTE
INCLINATO

COD. ART.

PER CONTENITORI
ART.

COD. ART.	PER CONTENITORI ART.
F ND 2120 00 99	F LS 7300 00 ..
	F LS 7301 00 ..
	F LS 8100 00 ..
	F LS 8101 00 ..
	F LS 8110 00 ..
	F LS 8900 00 ..
	F LS 8901 00 ..
F ND 2110 00 99	F LS 4100 00 ..
	F LS 6500 00 ..
	F LS 6501 00 ..

ETICHETTE PER
CONTENITORI E CASSETTE

COD. ART.

PER CASSETTE E
CONTENITORI ART.DIM. ETICHETTA
SINGOLA mmN. ETICHETTE
PER FOGLIO

COD. ART.	PER CASSETTE E CONTENITORI ART.	DIM. ETICHETTA SINGOLA mm	N. ETICHETTE PER FOGLIO
F LS 9020 00 00	F LS 1700 00 ..	47x17	60
	F LS 2500 00 ..		
F LS 9040 00 00	F LS 3300 00 ..	73x37	15
	F LS 5700 00 ..		
	F LS 4100 00 ..		
F LS 9060 00 00	F LS 4900 00 ..	80x48	12
	F LS 6500 00 ..		
	F LS 6501 00 ..		
	F LS 7300 00 ..		
	F LS 7301 00 ..		
F LS 9080 00 00	F LS 8900 00 ..	102x76	6
	F LS 8901 00 ..		
	F LS 8100 00 ..		
	F LS 8101 00 ..		
	F LS 8110 00 ..		



DIVISORI LONGITUDINALI IN METALLO

■ 99



Divisorio longitudinale in metallo con coppia supporti

COD. ART. **F ND 0130 01 99**

Per contenitori ART. F LS 4100 00 ..

COD. ART. **F ND 0190 01 99**Per contenitori ART. F LS 6500 00 ..
F LS 6501 00 ..COD. ART. **F ND 0221 01 99**Per contenitori ART. F LS 7300 00 ..
F LS 7301 00 ..COD. ART. **F ND 0221 02 99**Per contenitori ART. F LS 8100 00 ..
F LS 8101 00 ..
F LS 8110 00 ..COD. ART. **F ND 0241 01 99**Per contenitori ART. F LS 8900 00 ..
F LS 8901 00 ..
F LS 8910 00 ..

Divisorio longitudinale supplementare

COD. ART. **F ND 0130 00 99**

Per contenitori ART. F LS 4100 00 ..

COD. ART. **F ND 0190 00 99**Per contenitori ART. F LS 6500 00 ..
F LS 6501 00 ..COD. ART. **F ND 0221 00 99**Per contenitori ART. F LS 7300 00 ..
F LS 7301 00 ..
F LS 8100 00 ..
F LS 8101 00 ..
F LS 8110 00 ..COD. ART. **F ND 0241 00 99**Per contenitori ART. F LS 8900 00 ..
F LS 8901 00 ..
F LS 8910 00 ..

■ INFO

RAL 6011
F.02RAL 7000
F.01ZINCATO a caldo
F.99

www.famispaspa.com



SERIE STORAGE MULTIBOX

- PARETI RINFORZATE PER RESISTERE AGLI URTI
- DISPONIBILI IN 10 DIVERSE MISURE



Scaffali per cassette Multibox



Fermo in acciaio zincato che impedisce la fuoriuscita della cassetta dagli scaffali.



Disponibili divisori in polistirolo trasparente ed etichette.



Un'apposita maniglia, fornita su richiesta, facilita il sollevamento e il trasporto delle cassette Multibox serie F PK.



BLU
F. 04

LEGENDA ■



Le cassette contrassegnate con questo simbolo sono realizzate in materiale plastico completamente riciclabile.



CASSETTE MULTIBOX

SERIE STORAGE MULTIBOX

■ 04



COD. ART.	DIM. mm
F PK 0551 00 04	300x120x100 h
Dim. esterne mm	300x120x100 h
Dim. interne mm	255x94x89 h
Q.tà max di divisori trasversali inseribili	4 pz ART. F PK 7068 00 96

■ 04



COD. ART.	DIM. mm
F PK 1551 00 04	400x120x100 h
Dim. esterne mm	400x120x100 h
Dim. interne mm	358x98x89 h
Q.tà max di divisori trasversali inseribili	6 pz ART. F PK 7068 00 96

■ 04



COD. ART.	DIM. mm
F PK 3051 00 04	500x120x100 h
Dim. esterne mm	500x120x100 h
Dim. interne mm	460x94x89 h
Q.tà max di divisori trasversali inseribili	8 pz ART. F PK 7068 00 96

■ 04



COD. ART.	DIM. mm
F PK 1051 00 04	300x160x100 h
Dim. esterne mm	300x160x100 h
Dim. interne mm	260x135x89 h
Q.tà max di divisori trasversali inseribili	4 pz ART. F PK 7368 00 96

■ 04



COD. ART.	DIM. mm
F PK 2051 00 04	400x160x100 h
Dim. esterne mm	400x160x100 h
Dim. interne mm	358x135x90 h
Q.tà max di divisori trasversali inseribili	6 pz ART. F PK 7368 00 96

■ 04



COD. ART.	DIM. mm
F PK 3551 00 04	500x160x100 h
Dim. esterne mm	500x160x100 h
Dim. interne mm	460x135x89 h
Q.tà max di divisori trasversali inseribili	8 pz ART. F PK 7368 00 96

■ 04



COD. ART.	DIM. mm
F PK 4551 00 04	600x160x100 h
Dim. esterne mm	600x160x100 h
Dim. interne mm	560x135x90 h
Q.tà max di divisori trasversali inseribili	10 pz ART. F PK 7368 00 96

■ 04



COD. ART.	DIM. mm
F PK 2551 00 04	400x240x100 h
Dim. esterne mm	400x240x100 h
Dim. interne mm	358x215x89 h
Q.tà max di divisori trasversali inseribili	6 pz ART. F PK 7668 00 96

■ 04



COD. ART.	DIM. mm
F PK 4051 00 04	500x240x100 h
Dim. esterne mm	500x240x100 h
Dim. interne mm	462x214x89 h
Q.tà max di divisori trasversali inseribili	8 pz ART. F PK 7668 00 96

NEW

■ 04



COD. ART.	DIM. mm
F PK 2751 00 04	435x140x80 h
Dim. esterne mm	435x140x80 h
Dim. interne mm	420/405x125x70 h
Q.tà max di divisori trasversali inseribili	7 pz ART. F PK 7268 00 96



■ LEGENDA



Le cassette contrassegnate con questo simbolo sono realizzate in materiale plastico completamente riciclabile.



BLU
F.....04



SERIE STORAGE MULTIBOX

MANIGLIA



■ 04



COD. ART.

DIM. mm

F PK 6351 00 04**120x80 h**

Per cassette ART.

F PK 1051 00 04
F PK 2051 00 04
F PK 3551 00 04
F PK 4551 00 04

■ 04



COD. ART.

DIM. mm

F PK 6051 00 04**70x90 h**

Per cassette ART.

F PK 0551 00 04
F PK 1551 00 04
F PK 3051 00 04

■ 04



COD. ART.

DIM. mm

F PK 6651 00 04**110x90 h**

Per cassette ART.

F PK 2551 00 04
F PK 4051 00 04



inserimento maniglia
F PK 6351 00 04



inserimento maniglia
F PK 6051 00 04, F PK 6651 00 04

FERMI ■ 99

COD. ART.

Ø mm

F PK 9410 00 99**3**

Per cassette ART.

F PK 0551 00 04
F PK 1551 00 04
F PK 3051 00 04

COD. ART.

Ø mm

F PK 9420 00 99**3**

Per cassette ART.

F PK 1051 00 04
F PK 2051 00 04
F PK 3551 00 04
F PK 4551 00 04
F PK 2551 00 04
F PK 4051 00 04

I fermi evitano la fuoriuscita accidentale della cassetta dagli scaffali



DIVISORI LONGITUDINALI



■ 99



■ 99

COD. ART.

DIM. mm

F PK 9230 00 99**268x88 h**

PER CASSETTE ART.

F PK 0551 00 04
F PK 1051 00 04
F PK 1551 00 04
F PK 2051 00 04
F PK 2551 00 04

F PK 9240 00 99**368x88 h**

COD. ART.

DIM. mm

F PK 9250 00 99**468x88 h**

PER CASSETTE ART.

F PK 3051 00 04
F PK 3551 00 04
F PK 4051 00 04

F PK 9260 00 99**568x88 h**

F PK 4551 00 04

BLU
F. 04ZINCATO
F. 99

LEGENDA ■



Le maniglie contrassegnate con questo simbolo sono realizzate in materiale plastico completamente riciclabile.



DIVISORI TRASVERSALI



96



COD. ART. DIM. mm
F PK 7068 00 96 100x90 h

Per cassette ART. F PK 0551 00 04
 F PK 1551 00 04
 F PK 3051 00 04

96



COD. ART. DIM. mm
F PK 7368 00 96 145x90 h

Per cassette ART. F PK 1051 00 04
 F PK 2051 00 04
 F PK 3551 00 04
 F PK 4551 00 04

96



COD. ART. DIM. mm
F PK 7668 00 96 225x90 h

Per cassette ART. F PK 2551 00 04
 F PK 4051 00 04

96



COD. ART. DIM. mm
F PK 7268 00 96 137x75 h

Per cassette ART. F PK 2751 00 04



ETICHETTE PER CASSETTE

COD. ART.	PER CASSETTE ART.	DIM. ETICHETTA SINGOLA mm	N. ETICHETTE PER FOGLIO
F PK 9540 00 00	F PK 0551 00 04	81x42	12
	F PK 1551 00 04		
	F PK 3051 00 04		
F PK 9580 00 00	F PK 1051 00 04	121x44	8
	F PK 2051 00 04		
	F PK 3551 00 04		
	F PK 4551 00 04		
	F PK 2751 00 04		
F PK 9600 00 00	F PK 2551 00 04	200x43	6
	F PK 4051 00 04		



ETICHETTE PER DIVISORI

COD. ART.	PER DIVISORI ART.	DIM. ETICHETTA SINGOLA mm	N. ETICHETTE PER FOGLIO
F PK 9520 00 00	F PK 7068 00 96	80x24	24
	F PK 7268 00 96		
F PK 9560 00 00	F PK 7368 00 96	121x24	16
	F PK 7668 00 96		



■ LEGENDA



I divisori contrassegnati con questo simbolo sono realizzati in materiale plastico completamente riciclabile.

TRASPARENTE
 F. 99



SERIE STORAGE MULTIBOX

SCAFFALI PER CASSETTE MULTIBOX



Sovrapposizione scaffali con alette di posizionamento. Lo scaffale deve essere fissato a parete mediante 2 viti Ø foro 8 mm.

F PK 9030 00 01



F PK 9040 00 01



F PK 9050 00 01



F PK 9060 00 01



SCAFFALE SENZA MULTIBOX

F PK 9030 00 01

DIM. 500x300x545 mm h

F PK 9040 00 01

DIM. 500x400x545 mm h

F PK 9050 00 01

DIM. 500x500x545 mm h

F PK 9060 00 01

DIM. 500x600x545 mm h

SCAFFALE CON MULTIBOX

F PK 9030 01 01*

F PK 9030 02 01*

F PK 9030 03 01*

F PK 9040 01 01*

F PK 9040 02 01*

F PK 9040 03 01*

F PK 9040 04 01*

F PK 9040 05 01*

F PK 9040 06 01*

F PK 9040 07 01*

F PK 9050 01 01*

F PK 9050 02 01*

F PK 9050 03 01*

F PK 9050 04 01*

F PK 9050 05 01*

F PK 9050 06 01*

F PK 9050 07 01*

F PK 9060 02 01*

N. MULTIBOX DI SERIE

16 pezzi ART. F PK 0551 00 04

12 pezzi ART. F PK 1051 00 04

8 pezzi ART. F PK 0551 00 04

6 pezzi ART. F PK 1051 00 04

16 pezzi ART. F PK 1551 00 04

12 pezzi ART. F PK 2051 00 04

8 pezzi ART. F PK 1551 00 04

6 pezzi ART. F PK 2051 00 04

8 pezzi ART. F PK 2551 00 04

8 pezzi ART. F PK 1551 00 04

4 pezzi ART. F PK 2551 00 04

6 pezzi ART. F PK 2051 00 04

4 pezzi ART. F PK 2551 00 04

4 pezzi ART. F PK 1551 00 04

6 pezzi ART. F PK 2051 00 04

2 pezzi ART. F PK 2551 00 04

16 pezzi ART. F PK 3051 00 04

12 pezzi ART. F PK 3551 00 04

8 pezzi ART. F PK 3051 00 04

6 pezzi ART. F PK 3551 00 04

8 pezzi ART. F PK 4051 00 04

8 pezzi ART. F PK 3051 00 04

4 pezzi ART. F PK 4051 00 04

6 pezzi ART. F PK 3551 00 04

4 pezzi ART. F PK 4051 00 04

4 pezzi ART. F PK 3051 00 04

6 pezzi ART. F PK 3551 00 04

2 pezzi ART. F PK 4051 00 04

12 pezzi ART. F PK 4551 00 04

*Completi di guide e fermi per cassette

F PK 9030 01 01
F PK 9040 01 01
F PK 9050 01 01F PK 9030 02 01
F PK 9040 02 01
F PK 9050 02 01
F PK 9060 02 01F PK 9030 03 01
F PK 9040 03 01
F PK 9050 03 01F PK 9040 04 01
F PK 9050 04 01F PK 9040 05 01
F PK 9050 05 01F PK 9040 06 01
F PK 9050 06 01F PK 9040 07 01
F PK 9050 07 01RAL 7000
F. 01

INFO ■

www.famispa.com



SERIE STORAGE MULTIBOX

ZOCCOLI

COD. ART.	DIM. mm	PER SCAFFALE ART.
F PK 9135 00 01	485x275x90 h	F PK 9030 00 01
F PK 9145 00 01	485x375x90 h	F PK 9040 00 01
F PK 9155 00 01	485x475x90 h	F PK 9050 00 01
F PK 9165 00 01	485x575x90 h	F PK 9060 00 01



01



inserimento zoccolo



99

GUIDE

COD. ART.	PER SCAFFALE ARTICOLO
F ST 9830 00 99	F PK 9030 00 01
F ST 9840 00 99	F PK 9040 00 01
F ST 9850 00 99	F PK 9050 00 01
F ST 9860 00 99	F PK 9060 00 01

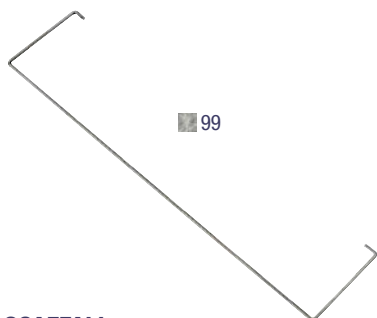
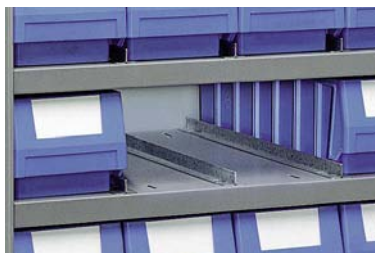

99

FERMI PER SCAFFALI

COD. ART.	PER SCAFFALE ARTICOLO
F PK 9360 00 99	F PK 9030 00 01 F PK 9040 00 01 F PK 9050 00 01 F PK 9060 00 01

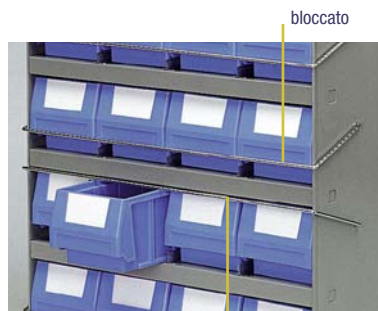

bloccato



aperto

■ INFO

ZINCATO
F. 99

RAL 7000
F. 01



www.famispa.com



SERIE STORAGE PRACTIBOX

- STRUTTURA IN ABS
- CASSETTI IN POLISTIROLO TRASPARENTE AD ALTA RESISTENZA MECCANICA
- COMODA APERTURA FRONTALE

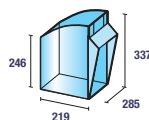
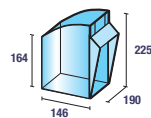
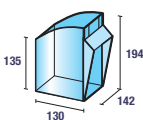
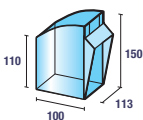
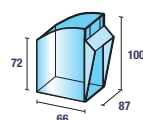
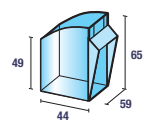

- PER LA PULIZIA DEI CASSETTI È SCONSIGLIATO L'USO DI SOLVENTI

Valigetta top-box



Sistema verticale Practibox



Carrello per cassettiere



Scaffali girevoli

RAL 7000
F... .. 01COLORE STRUTTURA
GRIGIO 01COLORE CASSETTI
TRASPARENTE F... ..96

INFO ■



ABS

struttura cassettiere



PS

cassetti

www.famispa.com

LUNGHEZZA = 600 mm

SERIE STORAGE PRACTIBOX

CASSETTIERE SINGOLE



■ 96 - cassetti ■ 01 - struttura

COD. ART. DIM. mm

F PG 1071 01 01 600x69x77 h

Cassetiera con 9 cassetti



■ 96 - cassetti ■ 01 - struttura

COD. ART. DIM. mm

F PG 1571 01 01 600x98x112 h

Cassetiera con 6 cassetti



■ 96 - cassetti ■ 01 - struttura

COD. ART. DIM. mm

F PG 2071 01 01 600x133x164 h

Cassetiera con 5 cassetti



■ 96 - cassetti ■ 01 - struttura

COD. ART. DIM. mm

F PG 2571 01 01 600x174x206 h

Cassetiera con 4 cassetti



■ 96 - cassetti ■ 01 - struttura

COD. ART. DIM. mm

F PG 3071 01 01 600x209x240 h

Cassetiera con 3 cassetti



■ 96 - cassetti ■ 01 - struttura

COD. ART. DIM. mm

F PG 3571 01 01 600x311x353 h

Cassetiera con 2 cassetti

DISPENSER DA BANCO



■ 01

COD. ART. DIM. mm

F PG 0320 00 01 610x150x500 h

Realizzato in lamiera d'acciaio verniciata



■ 96 - cassetti ■ 01 - struttura

COD. ART. DIM. mm

F PG 0320 01 01 610x189,5x500 h

Completo di
1 ART. F PG 1571 01 01
1 ART. F PG 2071 01 01
1 ART. F PG 2571 01 01

■ INFO

RAL 7000
F 01COLORE STRUTTURA
GRIGIO 01COLORE CASSETTI
TRASPARENTE F. 96

www.famispa.com



PS

cassetti



ABS

struttura cassetiera



SERIE STORAGE PRACTIBOX

SCAFFALI DA PARETE



■ 01

COD. ART.

F PG 0410 00 01Dim. mm **600x28x300 h**Realizzato in lamiera
d'acciaio verniciata

■ 96 - cassetti ■ 01 - struttura

COD. ART.

DIM. mm

F PG 0410 01 01 **600x78x308 h**

Completo di: 4 ART. F PG 1071 01 01



■ 96 - cassetti ■ 01 - struttura

COD. ART.

DIM. mm

F PG 0410 02 01 **600x107x300 h**Completo di: 1 ART. F PG 1071 01 01
2 ART. F PG 1571 01 01

■ 96 - cassetti ■ 01 - struttura

COD. ART.

DIM. mm

F PG 0410 03 01 **600x150x328 h**

Completo di: 2 ART. F PG 2071 01 01



■ 01

COD. ART.

F PG 0420 00 01Dim. mm **600x28x500 h**Realizzato in lamiera
d'acciaio verniciata

■ 96 - cassetti ■ 01 - struttura

COD. ART.

DIM. mm

F PG 0420 01 01 **600x78x500 h**

Completo di: 6 ART. F PG 1071 01 01



■ 96 - cassetti ■ 01 - struttura

COD. ART.

DIM. mm

F PG 0420 02 01 **600x107x500 h**Completo di: 2 ART. F PG 1071 01 01
3 ART. F PG 1571 01 01

■ 96 - cassetti ■ 01 - struttura

COD. ART.

DIM. mm

F PG 0420 03 01 **600x183x500 h**Completo di: 1 ART. F PG 1571 01 01
1 ART. F PG 2071 01 01
1 ART. F PG 2571 01 01

■ 01

COD. ART.

F PG 0430 00 01Dim. mm **600x28x650 h**Realizzato in lamiera
d'acciaio verniciata

■ 96 - cassetti ■ 01 - struttura

COD. ART.

DIM. mm

F PG 0430 01 01 **600x150x664 h**Completo di: 3 ART. F PG 1571 01 01
2 ART. F PG 2071 01 01

■ 96 - cassetti ■ 01 - struttura

COD. ART.

DIM. mm

F PG 0430 02 01 **600x107x650 h**Completo di: 1 ART. F PG 1071 01 01
5 ART. F PG 1571 01 01

■ 96 - cassetti ■ 01 - struttura

COD. ART.

DIM. mm

F PG 0430 03 01 **600x78x650 h**

Completo di: 8 ART. F PG 1071 01 01

Sistema di fissaggio alla parete
con tasselli e inserimento negli scaffali
delle cassette Practibox.RAL 7000
F. 01COLORE STRUTTURA
GRIGIO 01COLORE CASSETTI
TRASPARENTE F. 96

INFO ■



ABS

struttura cassettiera



PS

cassetti

www.famispa.com



LUNGHEZZA = 600 mm

SERIE STORAGE PRACTIBOX



01

COD. ART.

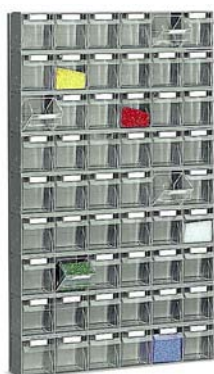
F PG 0530 00 01Dim. mm **600x41x1000 h**Realizzato in lamiera
d'acciaio verniciata

96 - cassetti 01 - struttura

COD. ART.

F PG 0530 02 01 600x113x1008 h

Completo di: 9 ART. F PG 1571 01 01

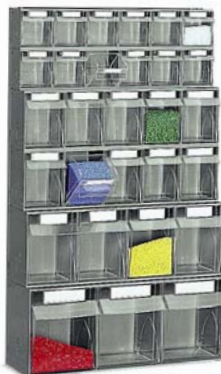

96 - cassetti 01 - struttura

COD. ART.

F PG 0530 03 01 600x224x1000 hCompleto di: 2 ART. F PG 1571 01 01
2 ART. F PG 2071 01 01
1 ART. F PG 2571 01 01
1 ART. F PG 3071 01 01

96 - cassetti 01 - struttura

COD. ART.

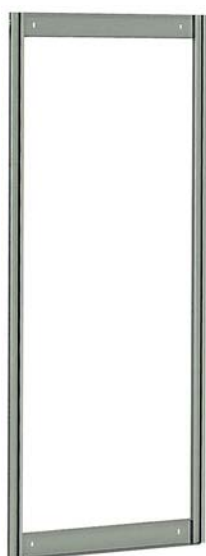
F PG 0530 04 01 600x113x1022 hCompleto di: 6 ART. F PG 1071 01 01
5 ART. F PG 1571 01 01

01

COD. ART.

F PG 0540 00 01Dim. mm **600x41x1500 h**Realizzato in lamiera
d'acciaio verniciata

96 - cassetti 01 - struttura

COD. ART.

F PG 0540 01 01 600x113x1508 hCompleto di: 9 ART. F PG 1071 01 01
7 ART. F PG 1571 01 01

96 - cassetti 01 - struttura

COD. ART.

F PG 0540 02 01 600x113x1568 h

Completo di: 14 ART. F PG 1571 01 01



96 - cassetti 01 - struttura

COD. ART.

F PG 0540 03 01 600x224x1540 hCompleto di: 2 ART. F PG 1071 01 01
4 ART. F PG 1571 01 01
3 ART. F PG 2071 01 01
1 ART. F PG 2571 01 01
1 ART. F PG 3071 01 01

■ INFO

RAL 7000
F. 01COLORE STRUTTURA
GRIGIO 01COLORE CASSETTI
TRASPARENTE F. 96
www.famispa.com

PS

cassetti



ABS

struttura cassettera



SERIE STORAGE PRACTIBOX



■ 01

COD. ART.**F PG 0550 00 01**Dim. mm **600x41x1750 h**Realizzato in lamiera
d'acciaio verniciata

■ 96 - cassetti ■ 01 - struttura

COD. ART.

DIM. mm

F PG 0550 01 01 600x113x1750 hCompleto di: 8 ART. F PG 1071 01 01
10 ART. F PG 1571 01 01

■ 96 - cassetti ■ 01 - struttura

COD. ART.

DIM. mm

F PG 0550 02 01 600x113x1757 hCompleto di: 1 ART. F PG 1071 01 01
15 ART. F PG 1571 01 01

■ 96 - cassetti ■ 01 - struttura

COD. ART.

DIM. mm

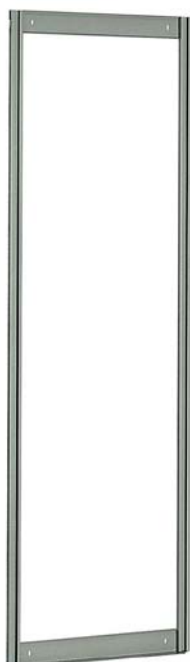
F PG 0550 03 01 600x224x1750 hCompleto di: 1 ART. F PG 1071 01 01
6 ART. F PG 1571 01 01
2 ART. F PG 2071 01 01
2 ART. F PG 2571 01 01
1 ART. F PG 3071 01 01

■ 01

COD. ART.**F PG 0560 00 01**Dim. mm **600x41x1950 h**Realizzato in lamiera
d'acciaio verniciata

■ 96 - cassetti ■ 01 - struttura

COD. ART.

DIM. mm

F PG 0560 01 01 600x113x1960 hCompleto di: 8 ART. F PG 1071 01 01
12 ART. F PG 1571 01 01

■ 96 - cassetti ■ 01 - struttura

COD. ART.

DIM. mm

F PG 0560 02 01 600x156x1950 hCompleto di: 3 ART. F PG 1071 01 01
8 ART. F PG 1571 01 01
5 ART. F PG 2071 01 01

■ 96 - cassetti ■ 01 - struttura

COD. ART.

DIM. mm

F PG 0560 03 01 600x326x1989 hCompleto di: 6 ART. F PG 2071 01 01
2 ART. F PG 2571 01 01
1 ART. F PG 3071 01 01
1 ART. F PG 3571 01 01RAL 7000
F 01COLORE STRUTTURA
GRIGIO 01COLORE CASSETTI
TRASPARENTE F. 96

INFO ■



ABS

struttura cassettera



PS

cassetti

www.famispa.com

LUNGHEZZA = 600 mm

SERIE STORAGE PRACTIBOX

SCAFFALI CON BASE

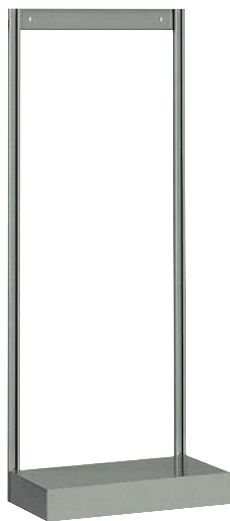

■ 01

COD. ART.**F PG 0640 00 01**Dim. mm **600x325x1500 h**

Altezza utile 1400 mm

Realizzato in lamiera
d'acciaio verniciata

■ 96 - cassetti ■ 01 - struttura

COD. ART.

DIM. mm

F PG 0640 01 01 600x325x1500 h

Completo di: 8 ART. F PG 1071 01 01

7 ART. F PG 1571 01 01



■ 96 - cassetti ■ 01 - struttura

COD. ART.

DIM. mm

F PG 0640 02 01 600x325x1556 h

Completo di: 13 ART. F PG 1571 01 01



■ 96 - cassetti ■ 01 - struttura

COD. ART.

DIM. mm

F PG 0640 03 01 600x325x1528 h

Completo di: 2 ART. F PG 1071 01 01

3 ART. F PG 1571 01 01

3 ART. F PG 2071 01 01

1 ART. F PG 2571 01 01

1 ART. F PG 3071 01 01

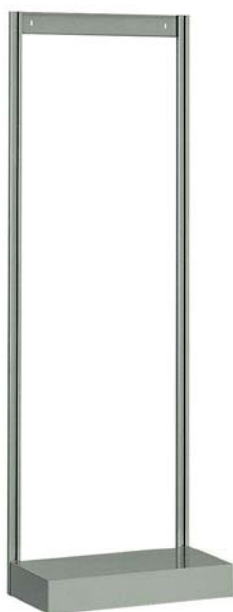

■ 01

COD. ART.**F PG 0650 00 01**Dim. mm **600x325x1750 h**

Altezza utile 1650 mm

Realizzato in lamiera
d'acciaio verniciata

■ 96 - cassetti ■ 01 - struttura

COD. ART.

DIM. mm

F PG 0650 02 01 600x325x1786 h

Completo di: 6 ART. F PG 1071 01 01

8 ART. F PG 1571 01 01

2 ART. F PG 2071 01 01



■ 96 - cassetti ■ 01 - struttura

COD. ART.

DIM. mm

F PG 0650 03 01 600x325x1750 h

Completo di: 2 ART. F PG 1071 01 01

3 ART. F PG 1571 01 01

3 ART. F PG 2071 01 01

2 ART. F PG 2571 01 01

1 ART. F PG 3071 01 01



■ 96 - cassetti ■ 01 - struttura

COD. ART.

DIM. mm

F PG 0650 04 01 600x325x1770 h

Completo di: 5 ART. F PG 1571 01 01

3 ART. F PG 2071 01 01

3 ART. F PG 2571 01 01

**BASE****COD. ART F PG 0610 00 01**Dimensioni mm **600x300x100 h**

Realizzato in lamiera d'acciaio verniciata

■ 01



■ INFO

RAL 7000
F 01COLORE STRUTTURA
GRIGIO 01COLORE CASSETTI
TRASPARENTE F. 96PS
cassettiABS
struttura cassettera

SERIE STORAGE PRACTIBOX

SCAFFALI CON BASE



■ 01

COD. ART.

F PG 0660 00 01Dim. mm **600x325x1950 h**

Altezza utile 1850 mm

Realizzato in lamiera
d'acciaio verniciata

■ 96 - cassetti ■ 01 - struttura

COD. ART.

DIM. mm

F PG 0660 01 01 600x325x1950 hCompleto di: 6 ART. F PG 1071 01 01
9 ART. F PG 1571 01 01
1 ART. F PG 2071 01 01
1 ART. F PG 2571 01 01

■ 96 - cassetti ■ 01 - struttura

COD. ART.

DIM. mm

F PG 0660 02 01 600x325x1950 hCompleto di: 2 ART. F PG 1071 01 01
3 ART. F PG 1571 01 01
3 ART. F PG 2071 01 01
3 ART. F PG 2571 01 01
1 ART. F PG 3071 01 01

■ 96 - cassetti ■ 01 - struttura

COD. ART.

DIM. mm

F PG 0660 03 01 600x325x1976 hCompleto di: 5 ART. F PG 1571 01 01
3 ART. F PG 2071 01 01
4 ART. F PG 2571 01 01

ETICHETTE



COD. ART.

PER CASSETTIERA ART.

F PG 9020 00 00

F PG 1071 01 01

F PG 9040 00 00

F PG 1571 01 01

F PG 9060 00 00

F PG 2071 01 01

F PG 9080 00 00

F PG 2571 01 01

F PG 9100 00 00

F PG 3071 01 01

F PG 9120 00 00

F PG 3571 01 01

FERMI PER CASSETTIERE

■ zincato

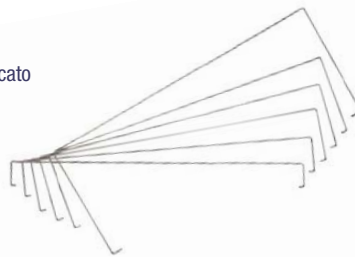

COD. ART.

PER CASSETTIERA ART.

F PG 0910 00 99

F PG 1071 01 01

F PG 0915 00 99

F PG 1571 01 01

F PG 0920 00 99

F PG 2071 01 01

F PG 0925 00 99

F PG 2571 01 01

F PG 0930 00 99

F PG 3071 01 01

F PG 0935 00 99

F PG 3571 01 01

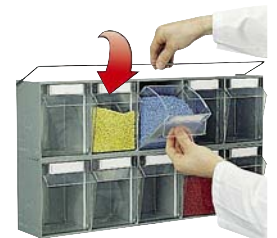

sistema di bloccaggio

RAL 7000
F 01COLORE STRUTTURA
GRIGIO 01COLORE CASSETTI
TRASPARENTE F.96

INFO ■

ABS
struttura cassetteriaPS
cassetti

www.famispa.com



LUNGHEZZA =750 mm

SERIE STORAGE PRACTIBOX

CARRELLO PER CASSETTIERE PRACTIBOX



Fronte



Retro



■ zincato + RAL 7000 F 52

■ Per i carrelli SMART vedi a pag. D2

COD. ART.

DIM. mm

F LB B073 04 52

725x613x1430 h

Completo di 2 coppie profili per Practibox,
2 ruote girevoli con freno e 2 ruote fisse in
gomma standard Ø 125 mm

Portata: 300 kg (150 kg per lato)

Carrello senza Practibox

VALIGETTA TOP BOX



■ 96 - cassetti ■ 04 - struttura

COD. ART.

DIM. mm

F PG 5561 01 04

350x200x465 h

Completa di 18 cassetti

SCAFFALE GIREVOLE PER CASSETTIERE PRACTIBOX

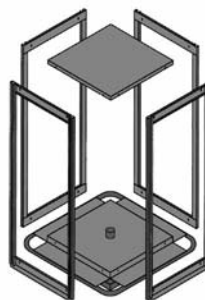

■ 96 - cassetti
■ 01 - struttura

■ Lo scaffale girevole deve essere obbligatoriamente fissato al pavimento



COD. ART.

CON 4 TELAI ART.

F PG 0226 01 01

F PG 0550 00 01

Completo di: 2 ART. F PG 1071 01 01
18 ART. F PG 1571 01 01
22 ART. F PG 2071 01 01
6 ART. F PG 2571 01 01

■ INFO

■ RAL 7000 F 01

■ COLORE STRUTTURA GRIGIO 01

■ COLORE CASSETTI TRASPARENTE F.96



www.famispa.com



PS
cassetti



ABS
struttura cassettera



SERIE STORAGE PRACTIBOX

■ SISTEMA VERTICALE PORTATA 100 KG

■ Questi armadi forniti di serie con dispositivo di apertura singola dei cassetti, **DEVONO ESSERE FISSATI** a pavimento o a parete.
Il materiale di fissaggio a pavimento, se richiesto, può essere fornito dalla **FAMI**.

■ Materiale di fissaggio Art. F SR 8999 00 99.
Adatto per pavimenti in calcestruzzo non fessurato, classe: RBK 250 / B 25 / MPA 25N per mm².



DIMENSIONI mm: 1119x705x2000 h. LARGHEZZA UTILE mm: 967

DIMENSIONI mm: 1527x705x2000 h. LARGHEZZA UTILE mm: 1375

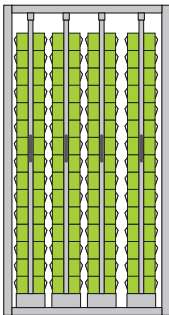

COD. ART. ■ 01

F PG 0035 01 01 Con serratura
F PG 0030 01 01 Senza serratura
con 4 cassetti senza Practibox

COD. ART. ■ 01

F PG 0035 51 01 Con serratura
F PG 0030 51 01 Senza serratura
con 4 cassetti completi di:
120 ART. F PG 1571 01 01

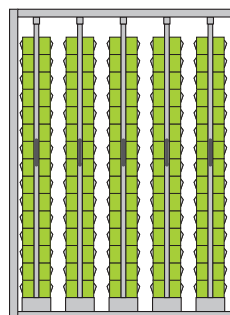

COD. ART. ■ 01

F PG 0055 01 01 Con serratura
F PG 0050 01 01 Senza serratura
con 5 cassetti senza Practibox

COD. ART. ■ 01

F PG 0055 51 01 Con serratura
F PG 0050 51 01 Senza serratura
con 5 cassetti completi di:
150 ART. F PG 1571 01 01

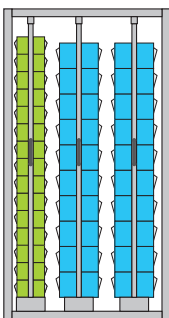

COD. ART. ■ 01

F PG 0035 02 01 Con serratura
F PG 0030 02 01 Senza serratura
con 3 cassetti senza Practibox

COD. ART. ■ 01

F PG 0035 52 01 Con serratura
F PG 0030 52 01 Senza serratura
con 3 cassetti completi di:
30 ART. F PG 1571 01 01
40 ART. F PG 2071 01 01

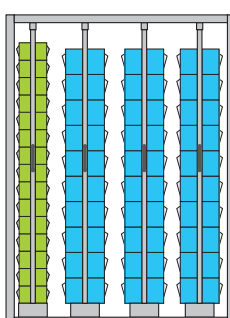

COD. ART. ■ 01

F PG 0055 02 01 Con serratura
F PG 0050 02 01 Senza serratura
con 4 cassetti senza Practibox

COD. ART. ■ 01

F PG 0055 52 01 Con serratura
F PG 0050 52 01 Senza serratura
con 4 cassetti completi di:
30 ART. F PG 1571 01 01
60 ART. F PG 2071 01 01

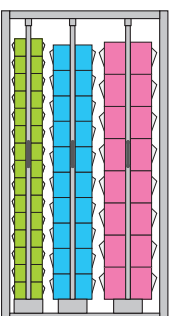

COD. ART. ■ 01

F PG 0035 03 01 Con serratura
F PG 0030 03 01 Senza serratura
con 3 cassetti senza Practibox

COD. ART. ■ 01

F PG 0035 53 01 Con serratura
F PG 0030 53 01 Senza serratura
con 3 cassetti completi di:
30 ART. F PG 1571 01 01
20 ART. F PG 2071 01 01
16 ART. F PG 2571 01 01

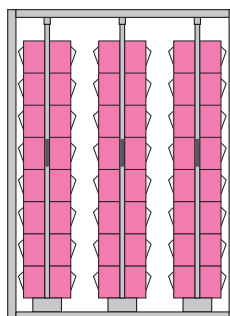

COD. ART. ■ 01

F PG 0055 03 01 Con serratura
F PG 0050 03 01 Senza serratura
con 3 cassetti senza Practibox

COD. ART. ■ 01

F PG 0055 53 01 Con serratura
F PG 0050 53 01 Senza serratura
con 3 cassetti completi di:
48 ART. F PG 2571 01 01

DIMENSIONI = 1073/1481x705x2000 mm

SERIE STORAGE PRACTIBOX



01

■ SISTEMA VERTICALE PORTATA 400 KG

■ Questi armadi forniti di serie con dispositivo di apertura singola dei cassetti, **DEVONO ESSERE FISSATI** a pavimento o a parete.
Il materiale di fissaggio a pavimento, se richiesto, può essere fornito dalla **FAMI**.

■ Materiale di fissaggio Art. F SR 8999 00 99.
Adatto per pavimenti in calcestruzzo non fessurato, classe: RBK 250 / B 25 / MPA 25N per mm².

DIMENSIONI mm: 1073x705x2000 h. LARGHEZZA UTILE mm: 967

DIMENSIONI mm: 1481x705x2000 h. LARGHEZZA UTILE mm: 1375

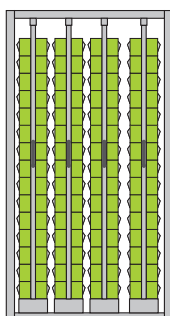

COD. ART. 01

F PG 0036 01 01 Con serratura
F PG 0031 01 01 Senza serratura
con 4 cassetti senza Practibox

COD. ART. 01

F PG 0036 51 01 Con serratura
F PG 0031 51 01 Senza serratura
con 4 cassetti completi di:
120 ART. F PG 1571 01 01

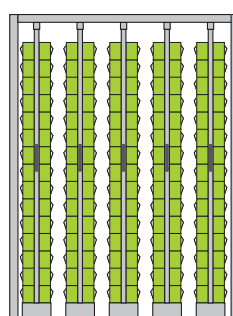

COD. ART. 01

F PG 0056 01 01 Con serratura
F PG 0051 01 01 Senza serratura
con 5 cassetti senza Practibox

COD. ART. 01

F PG 0056 51 01 Con serratura
F PG 0051 51 01 Senza serratura
con 5 cassetti completi di:
150 ART. F PG 1571 01 01

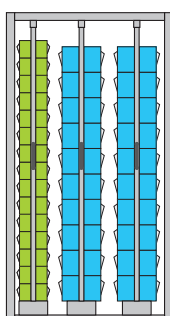

COD. ART. 01

F PG 0036 02 01 Con serratura
F PG 0031 02 01 Senza serratura
con 3 cassetti senza Practibox

COD. ART. 01

F PG 0036 52 01 Con serratura
F PG 0031 52 01 Senza serratura
con 3 cassetti completi di:
30 ART. F PG 1571 01 01
40 ART. F PG 2071 01 01

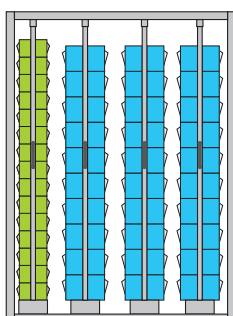

COD. ART. 01

F PG 0056 02 01 Con serratura
F PG 0051 02 01 Senza serratura
con 4 cassetti senza Practibox

COD. ART. 01

F PG 0056 52 01 Con serratura
F PG 0051 52 01 Senza serratura
con 4 cassetti completi di:
30 ART. F PG 1571 01 01
60 ART. F PG 2071 01 01

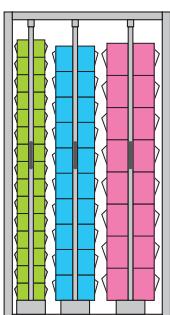

COD. ART. 01

F PG 0036 03 01 Con serratura
F PG 0031 03 01 Senza serratura
con 3 cassetti senza Practibox

COD. ART. 01

F PG 0036 53 01 Con serratura
F PG 0031 53 01 Senza serratura
con 3 cassetti completi di:
30 ART. F PG 1571 01 01
20 ART. F PG 2071 01 01
16 ART. F PG 2571 01 01

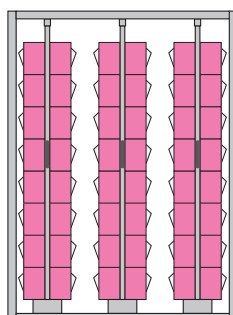

COD. ART. 01

F PG 0056 03 01 Con serratura
F PG 0051 03 01 Senza serratura
con 3 cassetti senza Practibox

COD. ART. 01

F PG 0056 53 01 Con serratura
F PG 0051 53 01 Senza serratura
con 3 cassetti completi di:
48 ART. F PG 2571 01 01

SERIE STORAGE GOLD BOX



Coperchio scorrevole con chiusura a scatto



Possibilità di chiusura del coperchio con sigillo di sicurezza

■ 01



■ 01



■ 01



COD. ART.

DIM. mm

F PH 3651 AC 01 227x180x100 h

Dim. esterne mm 227x180x100 h

Dim. interne mm 187x136x93 h

Capacità litri 3

Peso gr. 426

Colori di serie ■

Fondo **chiuso**Pareti lunghe **chiuso**Pareti corte **chiuso**Maniglie **chiuso**

COD. ART.

DIM. mm

F PH 4851 AC 01 336x231x100 h

Dim. esterne mm 336x231x100 h

Dim. interne mm 282x178x90 h

Capacità litri 5

Peso gr. 716

Colori di serie ■

Fondo **chiuso**Pareti lunghe **chiuso**Pareti corte **chiuso**Maniglie **chiuso**

COD. ART.

DIM. mm

F PH 5251 AC 01 336x231x150 h

Dim. esterne mm 336x231x150 h

Dim. interne mm 285x179x144 h

Capacità litri 8

Peso gr. 818

Colori di serie ■

Fondo **chiuso**Pareti lunghe **chiuso**Pareti corte **chiuso**Maniglie **chiuso**GRIGIO
F. 01

LEGENDA ■



Le cassette contrassegnate con questo simbolo sono idonee al contatto con gli alimenti.



Le cassette contrassegnate con questo simbolo sono realizzate in materiale plastico completamente riciclabile.



STORAGE SECURITY



■ 04

COD. ART.

DIM. mm

F PH CB51 00 04 147x98x53 h

Dim. esterne mm 147x98x53 h

Dim. interne mm 128x78x45 h

Capacità litri -

Peso gr. 124

Colori di serie ■



Per aprire il
coperchio premere
sulla parte centrale.

■ Coperchio con chiusura a scatto **NON RIUTILIZZABILE**

STORAGE SHELL



■ 04

COD. ART.

DIM. mm

F PH 0C51 00 04 148x110x28 h

Dim. esterne mm 148x110x28 h

Dim. interne mm 124x83x20 h

Capacità litri -

Peso gr. 66

Colori di serie ■



Coperchio a cerniera
con chiusura a scatto.
Possibilità di chiusura
del coperchio con sigillo
di sicurezza.



■ LEGENDA



Le cassette contrassegnate con questo simbolo sono realizzate in materiale plastico completamente riciclabile.

BLU
F.....04

SERIE STORAGE SYSTEM TR

- DISPONIBILE IN 2 DIVERSE ALTEZZA
- PER CASSETTE E CONTENITORI



■ 99



Piano superiore
in lamiera d'acciaio
zincata o verniciata.

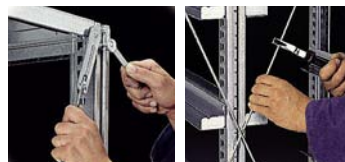

Diagonali di
irrigidimento
in lamiera
d'acciaio zincata.



Coppie guide
in lamiera d'acciaio
zincata.



■ 99



Piedini in lamiera d'acciaio zincata.

ZINCATO
F. 99

INFO ■

www.famispa.com





99

SET DI FISSAGGIO



■ Materiale per fissaggio composto da 2 viti ad espansione in acciaio M8x75 mm per pavimenti in calcestruzzo non fessurato uguali o maggiori alla classe: B25 / RBK250 / MPa 25 N per mm².

COD. ART. F NC 8999 00 99

■ I montanti vanno fissati a terra mediante tasselli.



99

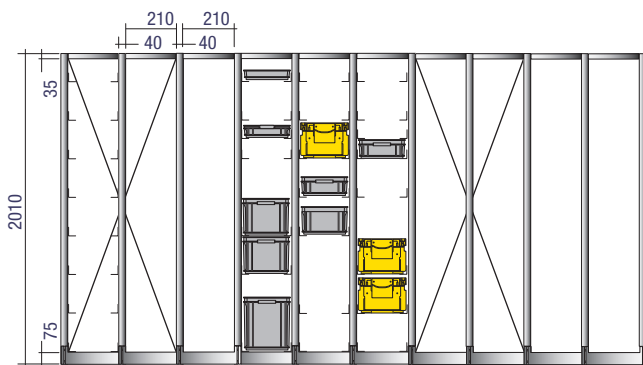

profondità scaffalatura 300 mm



■ Le crociere di irrigidimento sono realizzate in lamiera zincata. Per la stabilità delle scaffalature 2000 mm h è necessario installare una crociera ogni 6 campate.

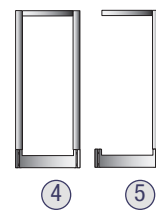
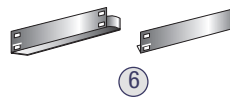
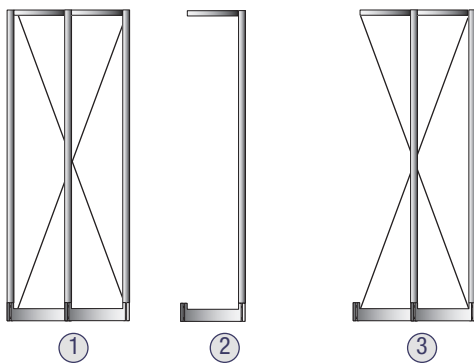
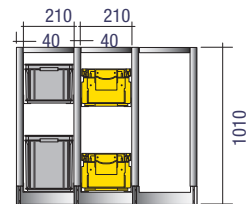

COD. ART.	TIPO DI CAMPATA mm	PORTATA PER CAMPATA kg
F TR D200 30 99	① Campata base doppia con crociera 2010 h	250
F TR E200 30 99	② Campata aggiuntiva singola 2010 h	250
F TR F200 30 99	③ Campata aggiuntiva doppia con crociera 2010 h	250
F TR G100 30 99	④ Campata base singola 1010 h	250
F TR E100 30 99	⑤ Campata aggiuntiva singola 1010 h	250
F TR 9000 00 99	⑥ Coppia guide zincate	50

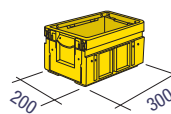
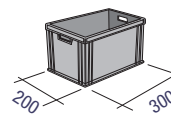

PER CASSETTE DIM. mm	PASSO CONSIGLIATO TRA LE GUIDE mm
300x200x120 h	150
300x200x170 h	200
300x200x147,5 h	175

■ **INFO**



www.famispa.com

ZINCATO
F. 99



SERIE STORAGE SYSTEM TR

SCAFFALATURA SERIE **F TR** PER CASSETTE 300x400

SET DI FISSAGGIO



■ Materiale per fissaggio composto da 2 viti ad espansione in acciaio M8x75 mm per pavimenti in calcestruzzo non fessurato uguali o maggiori alla classe: B25 / RBK250 / MPa 25 N per mm².

COD. ART. F NC 8999 00 99

■ I montanti vanno fissati a terra mediante tasselli.

COD. ART. F TR S200 B1 99

Completo di 44 cassette.
Dim. mm 1440x400x2010 h

COD. ART. F TR S100 B1 99

Completo di 18 cassette.
Dim. mm 1090x400x1010 h

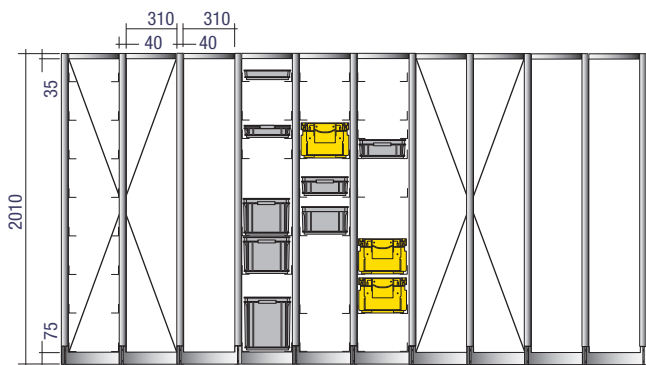

profondità scaffalatura 400 mm



■ Le crociere di irrigidimento sono realizzate in lamiera zincata. Per la stabilità delle scaffalature 2000 mm h è necessario installare una crociera ogni 6 campate.

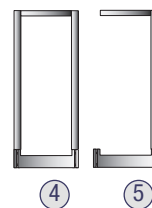
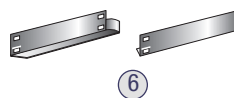
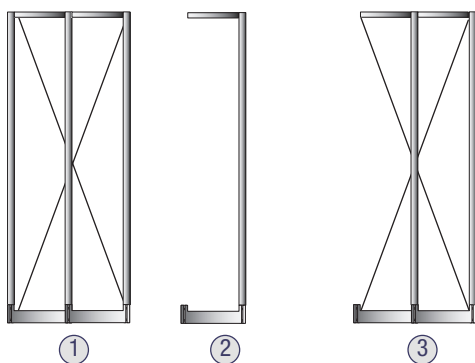
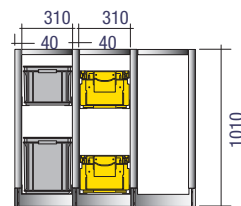

COD. ART.

TIPO DI CAMPATA
mm

PORTATA PER
CAMPATA kg

F TR D200 40 99	① Campata base doppia con crociera 2010 h	250
F TR E200 40 99	② Campata aggiuntiva singola 2010 h	250
F TR F200 40 99	③ Campata aggiuntiva doppia con crociera 2010 h	250
F TR G100 40 99	④ Campata base singola 1010 h	250
F TR E100 40 99	⑤ Campata aggiuntiva singola 1010 h	250
F TR 9040 00 99	⑥ Coppia guide zincate	50

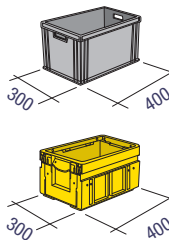

PER CASSETTE
DIM. mm

PASSO CONSIGLIATO
TRA LE GUIDE mm

400x300x55 h	75
400x300x78 h	100
400x300x120 h	150
400x300x170 h	200
400x300x220 h	250
400x300x325 h	350

ZINCATO
F.99

INFO ■

www.famispa.com





COD. ART. F TR S200 C2 99
Completo di 44 cassette.
Dim. mm 1840x600x2010 h

SET DI FISSAGGIO



■ Materiale per fissaggio composto da 2 viti ad espansione in acciaio M8x75 mm per pavimenti in calcestruzzo non fessurato uguali o maggiori alla classe: B25 / RBK250 / MPa 25 N per mm².

COD. ART. F NC 8999 00 99

■ I montanti vanno fissati a terra mediante tasselli.



COD. ART. F TR S100 C2 99
Completo di 18 cassette.
Dim. mm 1390x600x1010 h

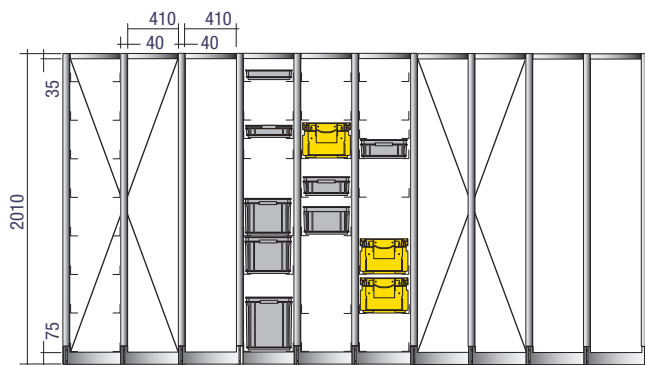

profondità scaffalatura 600 mm



■ Le crociere di irrigidimento sono realizzate in lamiera zincata. Per la stabilità delle scaffalature 2000 mm h è necessario installare una crociera ogni 6 campate.

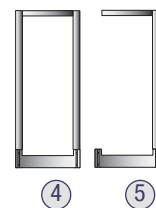
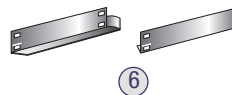
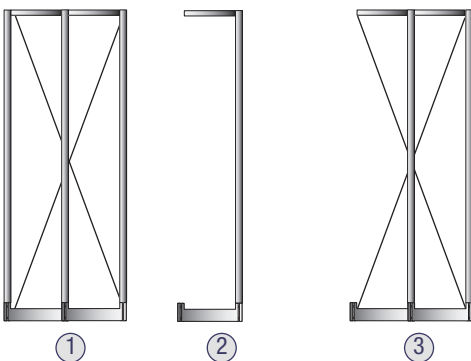
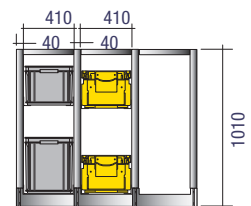

COD. ART.	TIPO DI CAMPATA mm	PORTATA PER CAMPATA kg
F TR D200 60 99	① Campata base doppia con crociera 2010 h	250
F TR E200 60 99	② Campata aggiuntiva singola 2010 h	250
F TR F200 60 99	③ Campata aggiuntiva doppia con crociera 2010 h	250
F TR G100 60 99	④ Campata base singola 1010 h	250
F TR E100 60 99	⑤ Campata aggiuntiva singola 1010 h	250
F TR 9080 00 99	⑥ Coppia guide zincate	50

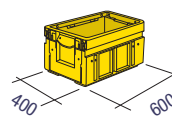
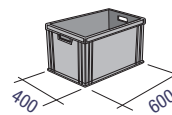

PER CASSETTE DIM. mm	PASSO CONSIGLIATO TRA LE GUIDE mm
600x400x78 h	100
600x400x120 h	150
600x400x170 h	200
600x400x220 h	250
600x400x285 h	325
600x400x325 h	350
600x400x430 h	450

■ **INFO**



www.famispa.com

ZINCATO
F.99



SERIE STORAGE SYSTEM TR

SCAFFALATURA SERIE **F TR 223x350** PER CONTENITORI MISURA **3A2/3**

COD. ART. F TR S200 D1 99
Completo di 50 contenitori.
Dim. mm 1355x350x2010 h

SET DI FISSAGGIO



■ Materiale per fissaggio composto da 2 viti ad espansione in acciaio M8x75 mm per pavimenti in calcestruzzo non fessurato uguali o maggiori alla classe: B25 / RBK250 / MPa 25 N per mm².

COD. ART. F NC 8999 00 99

■ I montanti vanno fissati a terra mediante tasselli.

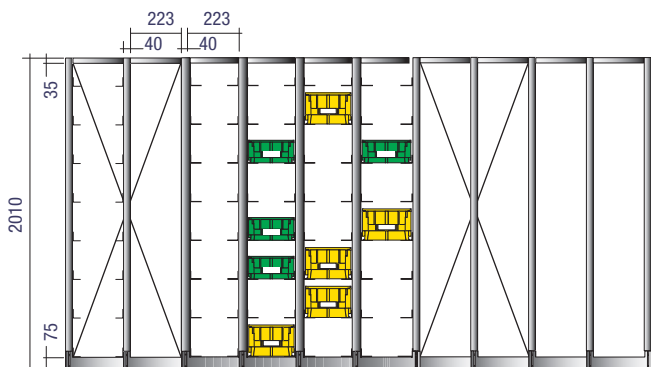

profondità scaffalatura 350 mm



■ Le crociere di irrigidimento sono realizzate in lamiera zincata. Per la stabilità delle scaffalature 2000 mm h è necessario installare una crociera ogni 6 campate.

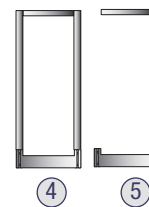
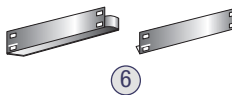
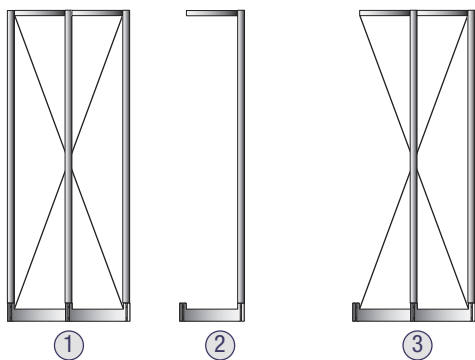
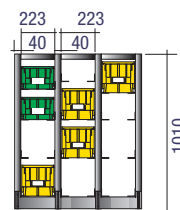

COD. ART.	TIPO DI CAMPATA mm	PORTATA PER CAMPATA kg
F TR D200 35 99	① Campata base doppia con crociera 2010 h	250
F TR E200 35 99	② Campata aggiuntiva singola 2010 h	250
F TR F200 35 99	③ Campata aggiuntiva doppia con crociera 2010 h	250
F TR G100 35 99	④ Campata base singola 1010 h	250
F TR E100 35 99	⑤ Campata aggiuntiva singola 1010 h	250
F TR 9020 00 99	⑥ Coppia guide zincate	50

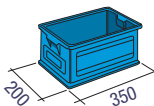
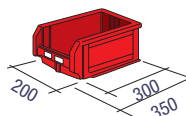

PER CASSETTE E CONTENITORI MISURA	PASSO CONSIGLIATO TRA LE GUIDE mm
3A2	175
3	225
272-3A2	175
272-3	225

ZINCATO
F. 99

INFO ■

www.famispa.com



SCAFFALATURA SERIE F TR 323x500 PER CONTENITORI MISURA 4/4A2/4A5



SET DI FISSAGGIO



■ Materiale per fissaggio composto da 2 viti ad espansione in acciaio M8x75 mm per pavimenti in calcestruzzo non fessurato uguali o maggiori alla classe: B25 / RBK250 / MPa 25 N per mm².

COD. ART. F NC 8999 00 99

■ I montanti vanno fissati a terra mediante tasselli.

COD. ART. F TR S200 E1 99

Completo di 50 contenitori.
Dim. mm 1129x500x2010 h

COD. ART. F TR S100 E2 99

Completo di 12 contenitori.
Dim. mm 1129x500x1010 h

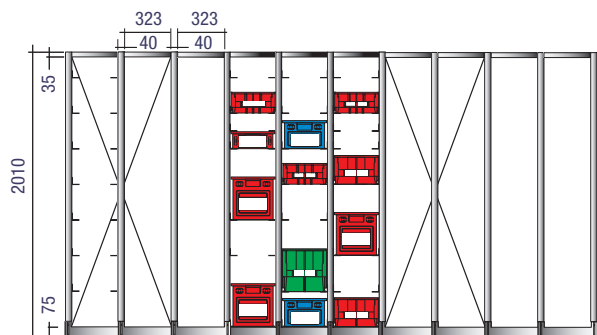

profondità scaffalatura 500 mm



■ Le crociere di irrigidimento sono realizzate in lamiera zincata. Per la stabilità delle scaffalature 2000 mm h è necessario installare una crociera ogni 6 campate.

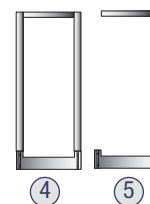
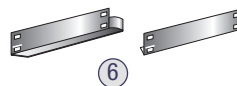
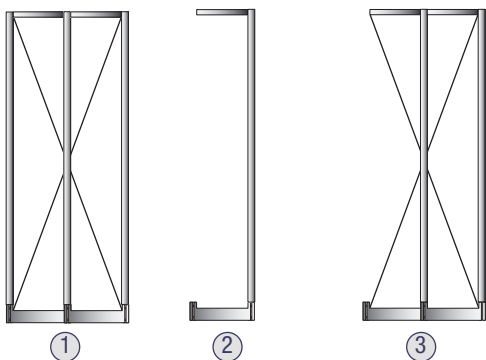
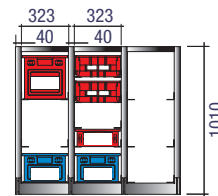

COD. ART.

TIPO DI CAMPATA
mm

PORTATA PER
CAMPATA kg

F TR D200 50 99	① Campata base doppia con crociera 2010 h	250
F TR E200 50 99	② Campata aggiuntiva singola 2010 h	250
F TR F200 50 99	③ Campata aggiuntiva doppia con crociera 2010 h	250
F TR G100 50 99	④ Campata base singola 1010 h	250
F TR E100 50 99	⑤ Campata aggiuntiva singola 1010 h	250
F TR 9060 00 99	⑥ Coppia guide zincate	50

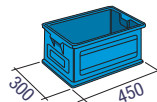
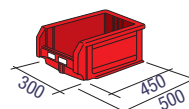

PER CASSETTE E
CONTENITORI MISURA

PASSO CONSIGLIATO
TRA LE GUIDE mm

272-4A2	150
272-4	225
272-4A5	325
4A2	200
4	225
4A5	325

■ INFO



www.famispa.com

ZINCATO
F. 99



SERIE **STORAGE DOMINO**■ PER CONTENITORI IN PLASTICA E
IN ACCIAIO

■ SOVRAPPONIBILI

■ Lo scaffale deve essere fissato a pavimento e/o a parete.

Applicando agli scaffali gli appositi accessori (zoccolo, piano di lavoro e coperchio parapolvere) si possono realizzare comodi e pratici banchi per la distribuzione dei materiali.



L'estrazione singola del contenitore avviene in modo semplice e rapido e un apposito gancio, di cui lo scaffale è provvisto, impedisce la fuoriuscita totale e accidentale del contenitore.



particolare del gancio

SCAFFALI SERIE **F ED 3044**

■ 01

■ Scaffale fornito **senza** contenitori



mis. 3
Contenitori:
vedi pag. da
G28 a G41

COD. ART. DIM. mm

F ED 3044 00 01 1025x310x885 h

Q. tà max di contenitori in metallo o polipropilene inseribili: **16 pezzi mis. 3**



SOVRAPPONIBILITÀ

COD. ART. SCAFFALE	Telai sovrapposti	Portata di ogni telaio	Portata di ogni box
F ED 3044 00 01	2 max 3	960 kg 640 kg	60 kg 40 kg

COD. ART. DIM. mm

F ED 9034 00 01 1020x315x20 h

Coperchio parapolvere

COD. ART. DIM. mm

F ED 9134 00 01 1025x315x32 h

Piano di lavoro

COD. ART. DIM. mm

F ED 9234 00 01 1020x315x85 h

Zoccolo

SCAFFALI SERIE **F ED 3074**

■ 01

■ Scaffale fornito **senza** contenitori



mis. 3
Contenitori:
vedi pag. da
G28 a G41

COD. ART. DIM. mm

F ED 3074 00 01 1765x310x885 h

Q. tà max di contenitori in metallo o polipropilene inseribili: **28 pezzi mis. 3**

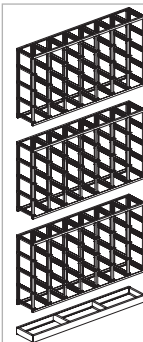

SOVRAPPONIBILITÀ

COD. ART. SCAFFALE	Telai sovrapposti	Portata di ogni telaio	Portata di ogni box
F ED 3074 00 01	2 max 3	1680 kg 1120 kg	60 kg 40 kg

COD. ART. DIM. mm

F ED 9037 00 01 1765x315x20 h

Coperchio parapolvere

COD. ART. DIM. mm

F ED 9137 00 01 1770x315x32 h

Piano di lavoro

COD. ART. DIM. mm

F ED 9237 00 01 1765x315x85 h

Zoccolo

RAL 7000
F. 01

INFO ■

www.famispa.com



PER CONTENITORI IN PLASTICA E IN ACCIAIO

SERIE STORAGE DOMINO

SCAFFALI SERIE F ED 4034



■ 01

■ Scaffale fornito **senza** contenitori



mis. 4
Contenitori:
vedi pag. da
G28 a G41

SOVRAPPONIBILITÀ

COD. ART. SCAFFALE	Telai sovrapposti	Portata di ogni telaio	Portata di ogni box
F ED 4034 00 01	max 3	1200 kg	100 kg

COD. ART. DIM. mm

F ED 4034 00 01 1075x460x885 h

Q. tà max di contenitori in metallo o polipropilene inseribili: 12 pezzi mis. 4



■ 01

COD. ART. DIM. mm

F ED 9043 00 01 1070x465x20 h

Coperchio parapolvere



■ 01

COD. ART. DIM. mm

F ED 9143 00 01 1075x465x32 h

Piano di lavoro



■ 01

COD. ART. DIM. mm

F ED 9243 00 01 1070x465x85 h

Zoccolo

SCAFFALI SERIE F ED 4054



■ 01

■ Scaffale fornito **senza** contenitori



mis. 4
Contenitori:
vedi pag. da
G28 a G41

SOVRAPPONIBILITÀ

COD. ART. SCAFFALE	Telai sovrapposti	Portata di ogni telaio	Portata di ogni box
F ED 4054 00 01	max 3	1600 kg	80 kg

COD. ART. DIM. mm

F ED 4054 00 01 1765x460x885 h

Q. tà max di contenitori in metallo o polipropilene inseribili: 20 pezzi mis. 4



■ 01

COD. ART. DIM. mm

F ED 9045 00 01 1765x465x20 h

Coperchio parapolvere

Per scaffali ART. F ED 4054 00 01 / F ED 4056 00 01



■ 01

COD. ART. DIM. mm

F ED 9145 00 01 1770x465x32 h

Piano di lavoro

Per scaffali ART. F ED 4054 00 01 / F ED 4056 00 01



■ 01

COD. ART. DIM. mm

F ED 9245 00 01 1765x465x85 h

Zoccolo

Per scaffali ART. F ED 4054 00 01 / F ED 4056 00 01

SCAFFALI SERIE F ED 4056



■ 01

■ Scaffale fornito **senza** contenitori



mis. 4
Contenitori:
vedi pag. da
G28 a G41

SOVRAPPONIBILITÀ

COD. ART. SCAFFALE	Telai sovrapposti	Portata di ogni telaio	Portata di ogni box
F ED 4056 00 01	2 max 3	2400 kg 1500 kg	80 kg 50 kg

COD. ART. DIM. mm

F ED 4056 00 01 1765x460x1300 h

Q. tà max di contenitori in metallo o polipropilene inseribili: 30 pezzi mis. 4



■ 01

COD. ART. DIM. mm

F ED 9045 00 01 1765x465x20 h

Coperchio parapolvere

Per scaffali ART. F ED 4054 00 01 / F ED 4056 00 01



■ 01

COD. ART. DIM. mm

F ED 9145 00 01 1770x465x32 h

Piano di lavoro

Per scaffali ART. F ED 4054 00 01 / F ED 4056 00 01



■ 01

COD. ART. DIM. mm

F ED 9245 00 01 1765x465x85 h

Zoccolo

Per scaffali ART. F ED 4054 00 01 / F ED 4056 00 01

■ INFO

RAL 7000
F. 01



www.famispa.com



SERIE **STORAGE DOMINO**SCAFFALI SERIE **F ED 4555**

■ 01

■ Scaffale
fornito **senza**
contenitorimis. 4A5
Contenitori:
vedi pag. da
G28 a G41

COD. ART. DIM. mm

F ED 4555 00 01 1765x460x1300 hQ. tà max di contenitori in metallo o polipropilene inseribili: **20 pezzi mis. 4A5**

■ 01

COD. ART. DIM. mm

F ED 9045 00 01 1765x465x20 h

Coperchio parapolvere



■ 01

COD. ART. DIM. mm

F ED 9145 00 01 1770x465x32 h

Piano di lavoro



■ 01

COD. ART. DIM. mm

F ED 9245 00 01 1765x465x85 h

Zoccolo

SOVRAPPONIBILITÀ			
COD. ART. SCAFFALE	Telai sovrapposti	Portata di ogni telaio	Portata di ogni box
F ED 4555 00 01	2 max 3	1600 kg 1000 kg	80 kg 50 kg

SCAFFALI SERIE **F ED 5023**

■ 01

■ Scaffale
fornito **senza**
contenitorimis. 5
Contenitori:
vedi pag. da
G28 a G41

COD. ART. DIM. mm

F ED 5023 00 01 1125x660x1180 hQ. tà max di contenitori in metallo o polipropilene inseribili: **6 pezzi mis. 5**

■ 01

COD. ART. DIM. mm

F ED 9052 00 01 1120x665x30 h

Coperchio parapolvere



■ 01

COD. ART. DIM. mm

F ED 9352 00 01 1125x660x155 h

Zoccolo

SOVRAPPONIBILITÀ			
COD. ART. SCAFFALE	Telai sovrapposti	Portata di ogni telaio	Portata di ogni box
F ED 5023 00 01	max 3	1200 kg	200 kg

SCAFFALI SERIE **F ED 5033**

■ 01

■ Scaffale
fornito **senza**
contenitorimis. 5
Contenitori:
vedi pag. da
G28 a G41

COD. ART. DIM. mm

F ED 5033 00 01 1670x660x1180 hQ. tà max di contenitori in metallo o polipropilene inseribili: **9 pezzi mis. 5**

■ 01

COD. ART. DIM. mm

F ED 9053 00 01 1667x665x30 h

Coperchio parapolvere



■ 01

COD. ART. DIM. mm

F ED 9353 00 01 1670x660x155 h

Zoccolo

SOVRAPPONIBILITÀ			
COD. ART. SCAFFALE	Telai sovrapposti	Portata di ogni telaio	Portata di ogni box
F ED 5033 00 01	max 3	1800 kg	200 kg

RAL 7000
F. 01

INFO ■



SCALE CON DISPOSITIVO DI ROTAZIONE PER SCAFFALI STORAGE DOMINO

SCALE CON DISPOSITIVO DI ROTAZIONE PER SCAFFALI STORAGE DOMINO

La scala permette di raggiungere con facilità e sicurezza anche i contenitori situati nella parte alta dello scaffale. Studiata e realizzata per operare in totale sicurezza, la scala scorre su rotaie e grazie al dispositivo di rotazione, può essere aperta verso destra o verso sinistra o chiusa per lasciare libero il passaggio nel corridoio. Può essere bloccata in posizione con un freno che viene poi allentato per consentire un nuovo spostamento.



■ SICUREZZA

La sicurezza della scala dipende dalla stabilità dell'impianto a cui viene ancorata. Per ulteriori informazioni richiedere la scheda tecnica.

La sovrapposizione degli scaffali permette di realizzare veri e propri magazzini studiando soluzioni personalizzate di sviluppo in altezza e in larghezza a seconda delle necessità.



SERIE STORAGE DOMINO

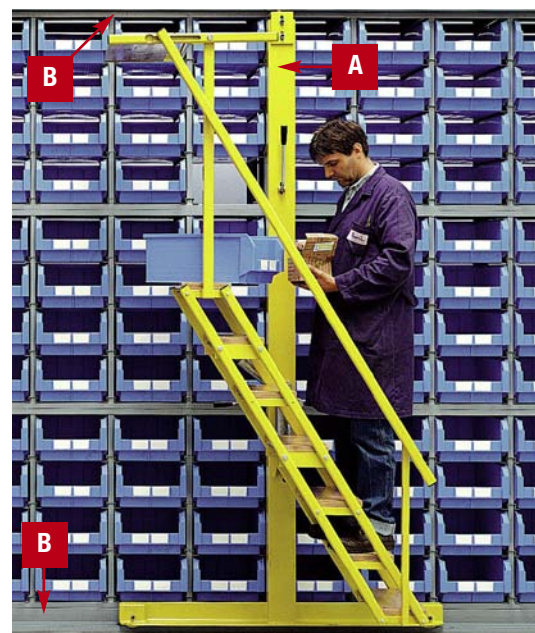

■ 30

COD. ART. SCALA **A**

PER SCAFFALI

F QG 2227 00 30 altezza scala 2270 mm	F ED 4054 00 01+ F ED 4056 00 01+ F ED 9245 00 01	-	-	-
F QG 2251 00 30 altezza scala 2515 mm	F ED 5023 00 01+ F ED 5023 00 01+ F ED 9352 00 01	F ED 5033 00 01+ F ED 5033 00 01+ F ED 9353 00 01+	-	-
F QG 2270 00 30 altezza scala 2685-2740 mm	F ED 3044 00 01+ F ED 3044 00 01+ F ED 3044 00 01+ F ED 9234 00 01	F ED 3074 00 01+ F ED 3074 00 01+ F ED 3074 00 01+ F ED 9237 00 01	F ED 4034 00 01+ F ED 4034 00 01+ F ED 4034 00 01+ F ED 9243 00 01	F ED 4054 00 01+ F ED 4054 00 01+ F ED 4054 00 01+ F ED 9245 00 01
F QG 2270 00 30 altezza scala 2685-2740 mm	F ED 4056 00 01+ F ED 4056 00 01+ F ED 9245 00 01	F ED 4555 00 01+ F ED 4555 00 01+ F ED 9245 00 01	-	-

GUIDE APPLICABILI ALLA SCAFFALATURA

COD. ART. **B**

F QG 9200 00 01

Guide inferiori e superiori al metro lineare

N.B. Le scaffalature possono essere sovrapposte solo con elementi che abbiano il perimetro uguale tra di loro

- 01
- 02
- 04
- 08

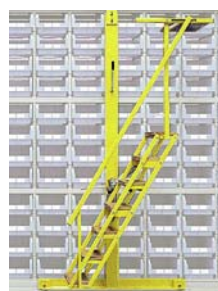

posizione di scala sinistra



posizione di scala chiusa



posizione di scala destra

■ 30

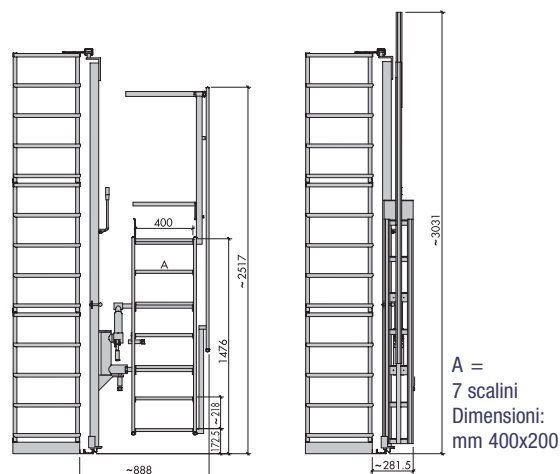

■ INFO

- RAL 7000 F.01
- RAL 6011 F.02
- RAL 5012 F.04
- RAL 7035 F.08
- RAL 1004 F.30



www.famispa.com

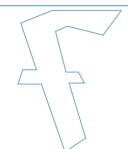

SERIE STORAGE ESD ATHENA

CASSETTE CONDUTTIVE SERIE ATHENA

- SPECIALE PLASTICA CONDUTTIVA FAMI 408 L
- PARTICOLARMENTE INDICATI PER L'INDUSTRIA ELETTRONICA



CARATTERISTICHE TECNICHE

Materiale di base	Polipropilene copolimero (PPC)
Additivo elettroconduttivo	Carbon black
Colore	Nero
Densità, a 23°C	1.04 g/cm ³
Punto di rammollimento di Vicat	154°C ISO 306
Temperatura di utilizzazione permanente	ca. 80-100°C
per breve tempo	ca. 100-120°C
Resistenza di superficie	< 10 ⁴ Ω cm (misurata secondo CEI EN 61340-2-3 a 20°C con elettrodo anulare 5 cm ²).
Resistività specifica	10 ⁴ Ω cm (misurata secondo CEI EN 61340-2-3 a 20°C con elettrodo anulare 5 cm ²)
Invecchiamento	Nessuna diminuzione secondo conduttività (in 7 anni d'impiego) nessuna migrazione di sostanze corrosive, eccellente resistenza ai raggi UV.
Resistenza agli agenti chimici	Ottima (secondo la classificazione PP, generalmente valida)

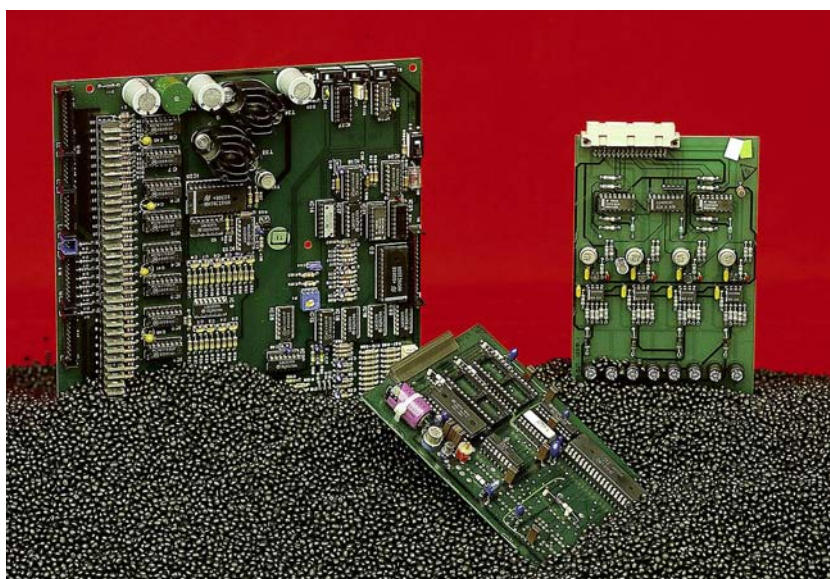

resistenza agli urti



coperchio a battente



coperchio a scorrimento

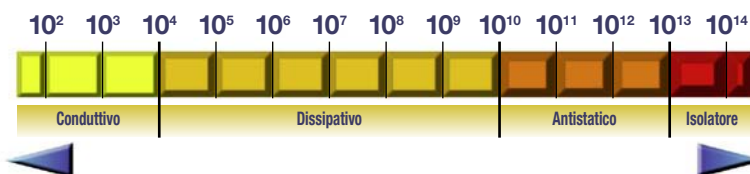

SCALA DELLA CONDUTTIVITÀ

NERO
F.07

LEGENDA ■



Le cassette contrassegnate con questo simbolo sono realizzate in materiale plastico completamente riciclabile.

- Robuste e resistenti ad alte e basse temperature



DIMENSIONI = 300x200 / 400x300 mm

SERIE STORAGE ESD ATHENA

CASSETTE CONDUTTIVE SERIE ATHENA 300x200



COD. ART.	DIM. mm
F PA 2452 A0 07	300x200x120 h
Dim. esterne mm	300x200x120 h. Dim. interne mm 260x160x100 h
Capacità litri	5
Peso gr.	520
Fondo	chiuso
Pareti lunghe	chiuse
Pareti corte	chiuse
Maniglie	chiuse

Porta etichette: ART. **F PZ 0010 00 99**. Vedi pag. G77

COPERCHI PER CASSETTE CONDUTTIVE



COD. ART.	PER CASSETTE ATHENA mm	TIPO COPERCHIO
F PA 0352 00 07	300x200	incernierato
F PA 0652 00 07	400x300	incernierato
F PA 1B52 00 07	400x300	con maniglie
F PA 1652 00 07	400x300	scorrevole
F PA 0952 00 07	600x400	incernierato
F PA 1C52 00 07	600x400	con maniglie
F PA 1252 00 07	800x600	-
F PA 1252 01 07	800x600	con maniglie

CASSETTE CONDUTTIVE SERIE ATHENA 400x300



COD. ART.	DIM. mm
F PA 3252 A0 07	400x300x55 h
Dim. esterne mm	400x300x55 h
Dim. interne mm	355x254x37 h
Capacità litri	3,8
Peso gr.	540
Fondo	chiuso
Pareti lunghe	chiuse
Pareti corte	chiuse
Maniglie	chiuse

Porta etichette: ART. **F PZ 0010 00 99**. Vedi pag. G77



COD. ART.	DIM. mm
F PA 3652 A0 07	400x300x78 h
Dim. esterne mm	400x300x78 h
Dim. interne mm	355x255x59 h
Capacità litri	6
Peso gr.	640
Fondo	chiuso
Pareti lunghe	chiuse
Pareti corte	chiuse
Maniglie	chiuse

Porta etichette: ART. **F PZ 0010 00 99**. Vedi pag. G77



COD. ART.	DIM. mm
F PA 4052 A0 07	400x300x120 h
Dim. esterne mm	400x300x120 h
Dim. interne mm	357x257x102 h
Capacità litri	10
Peso gr.	890
Fondo	chiuso
Pareti lunghe	chiuse
Pareti corte	chiuse
Maniglie	chiuse

Porta etichette: ART. **F PZ 0010 00 99**. Vedi pag. G77



COD. ART.	DIM. mm
F PA 4452 A0 07	400x300x170 h
Dim. esterne mm	400x300x170 h
Dim. interne mm	357x257x152 h
Capacità litri	15
Peso gr.	1220
Fondo	chiuso
Pareti lunghe	chiuse
Pareti corte	chiuse
Maniglie	chiuse

Porta etichette: ART. **F PZ 9551 00 07**
ART. **F PZ 0010 00 99**. Vedi pag. G77



COD. ART.	DIM. mm
F PA 4852 A0 07	400x300x220 h
Dim. esterne mm	400x300x220 h
Dim. interne mm	357x258x207 h
Capacità litri	20
Peso gr.	1360
Fondo	chiuso
Pareti lunghe	chiuse
Pareti corte	chiuse
Maniglie	chiuse

Porta etichette: ART. **F PZ 9551 00 07**
ART. **F PZ 0010 00 99**. Vedi pag. G77



COD. ART.	DIM. mm
F PA 5252 A0 07	400x300x325 h
Dim. esterne mm	400x300x325 h
Dim. interne mm	356x255x307 h
Capacità litri	30
Peso gr.	2240
Fondo	chiuso
Pareti lunghe	chiuse
Pareti corte	chiuse
Maniglie	chiuse

Porta etichette: ART. **F PZ 9551 00 07**
ART. **F PZ 0010 00 99**. Vedi pag. G77

■ LEGENDA



Le cassette contrassegnate con questo simbolo sono realizzate in materiale plastico completamente riciclabile.

■ Robuste e resistenti ad alte e basse temperature



■ NERO
F. 07

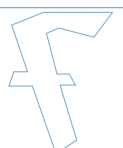

SERIE STORAGE ESD ATHENA



■ 07

COD. ART.

DIM. mm

F PA 5652 AO 07 600x400x78 h

Dim. esterne mm 600x400x78 h

Dim. interne mm 555x355x60 h

Capacità litri 10

Peso gr. 1600

Fondo **chiuso**Pareti lunghe **chiuso**Pareti corte **chiuso**Maniglie **chiuso**

Porta etichette: ART. F PZ 0010 00 99

Vedi pag. G77



■ 07

COD. ART.

DIM. mm

F PA 6052 AO 07 600x400x120 h

Dim. esterne mm 600x400x120 h

Dim. interne mm 557x357x102 h

Capacità litri 20

Peso gr. 1750

Fondo **chiuso**Pareti lunghe **chiuso**Pareti corte **chiuso**Maniglie **chiuso**

Porta etichette: ART. F PZ 0010 00 99

Vedi pag. G77



■ 07

COD. ART.

DIM. mm

F PA 6452 AO 07 600x400x170 h

Dim. esterne mm 600x400x170 h

Dim. interne mm 560x358x153 h

Capacità litri 30

Peso gr. 2310

Fondo **chiuso**Pareti lunghe **chiuso**Pareti corte **chiuso**Maniglie **chiuso**

Porta etichette: ART. F PZ 9751 00 07

ART. F PZ 0010 00 99. Vedi pag. G77



■ 07

COD. ART.

DIM. mm

F PB 6852 AO 07 600x400x220 h

Dim. esterne mm 600x400x220 h

Dim. interne mm 555x355x203 h

Capacità litri 40

Peso gr. 2160

Fondo **chiuso**Pareti lunghe **chiuso**Pareti corte **chiuso**Maniglie **chiuso**

Porta etichette: ART. F PZ 9751 00 07

ART. F PZ 0010 00 99. Vedi pag. G77



■ 07

COD. ART.

DIM. mm

F PA 7252 AO 07 600x400x285 h

Dim. esterne mm 600x400x285 h

Dim. interne mm 557x356x263 h

Capacità litri 53

Peso gr. 3358

Fondo **chiuso**Pareti lunghe **chiuso**Pareti corte **chiuso**Maniglie **chiuso**

Porta etichette: ART. F PZ 9751 00 07

ART. F PZ 0010 00 99. Vedi pag. G77



■ 07

COD. ART.

DIM. mm

F PA 7652 AO 07 600x400x325 h

Dim. esterne mm 600x400x325 h

Dim. interne mm 558x358x308 h

Capacità litri 60

Peso gr. 3620

Fondo **chiuso**Pareti lunghe **chiuso**Pareti corte **chiuso**Maniglie **chiuso**

Porta etichette: ART. F PZ 9751 00 07

ART. F PZ 0010 00 99. Vedi pag. G77



■ 07

COD. ART.

DIM. mm

F PA 8052 B0 07 600x400x430 h

Dim. esterne mm 600x400x430 h

Dim. interne mm 557x356x415 h

Capacità litri 90

Peso gr. 4250

Fondo **chiuso**Pareti lunghe **chiuso**Pareti corte **chiuso**Maniglie **aperte**

Porta etichette: ART. F PZ 9751 00 07

ART. F PZ 0010 00 99. Vedi pag. G77

NERO
F. 07

LEGENDA ■



Le cassette contrassegnate con questo simbolo sono realizzate in materiale plastico completamente riciclabile.

- Robuste e resistenti ad alte e basse temperature



DIMENSIONI = 800x600 mm

SERIE STORAGE ESD ATHENA



■ 07

Fondo rinforzato



COD. ART.

DIM. mm

F PA 8552 AO 07 800x600x120 h

Dim. esterne mm 800x600x120 h

Dim. interne mm 757x557x86 h

Capacità litri 49

Peso gr. 3920

Fondo **rinforzato**

Pareti lunghe **chiuse**

Pareti corte **chiuse**

Maniglie **chiuse**

Porta etichette: ART. **F PZ 0010 00 99**

Vedi pag. G77



■ 07

Fondo rinforzato



COD. ART.

DIM. mm

F PA 8752 AO 07 800x600x170 h

Dim. esterne mm 800x600x170 h

Dim. interne mm 758x555x137 h

Capacità litri 69

Peso gr. 4356

Fondo **rinforzato**

Pareti lunghe **chiuse**

Pareti corte **chiuse**

Maniglie **chiuse**

Porta etichette: ART. **F PZ 9751 00 07**

ART. **F PZ 0010 00 99**. Vedi pag. G77



■ 07

Fondo rinforzato



COD. ART.

DIM. mm

F PA 8952 AO 07 800x600x220 h

Dim. esterne mm 800x600x220 h

Dim. interne mm 757x556x188 h

Capacità litri 90

Peso gr. 5310

Fondo **rinforzato**

Pareti lunghe **chiuse**

Pareti corte **chiuse**

Maniglie **chiuse**

Porta etichette: ART. **F PZ 9751 00 07**

ART. **F PZ 0010 00 99**. Vedi pag. G77



■ Particolare del fondo rinforzato delle cassette 800x600 mm



■ 07

Fondo rinforzato



COD. ART.

DIM. mm

F PA 9352 AO 07 800x600x325 h

Dim. esterne mm 800x600x325 h

Dim. interne mm 756x555x294 h

Capacità litri 130

Peso gr. 5780

Fondo **rinforzato**

Pareti lunghe **chiuse**

Pareti corte **chiuse**

Maniglie **chiuse**

Porta etichette: ART. **F PZ 9751 00 07**

ART. **F PZ 0010 00 99**. Vedi pag. G77



■ 07

Fondo rinforzato



COD. ART.

DIM. mm

F PA 9752 AO 07 800x600x430 h

Dim. esterne mm 800x600x430 h

Dim. interne mm 756x555x395 h

Capacità litri 175

Peso gr. 6750

Fondo **rinforzato**

Pareti lunghe **chiuse**

Pareti corte **chiuse**

Maniglie **chiuse**

Porta etichette: ART. **F PZ 9751 00 07**

ART. **F PZ 0010 00 99**. Vedi pag. G77



■ Fondo liscio a richiesta

COPERCHI PER CASSETTE CONDUTTIVE SERIE ATHENA



■ 07

COD. ART.

COPERCHIO

F PA 1252 01 07 800x600

Peso gr. 1925

Cassette articolo F PA 8552 AO 07



■ 07

COD. ART.

COPERCHIO

F PA 1252 00 07 800x600

Peso gr. 2160

Cassette articolo F PA 8752 AO 07, F PA 8952 AO 07, F PA 9352 AO 07, F PA 9752 AO 07

■ LEGENDA



Le cassette contrassegnate con questo simbolo sono realizzate in materiale plastico completamente riciclabile.

■ Robuste e resistenti ad alte e basse temperature



PP



■ NERO
F. 07



SERIE STORAGE ESD ATHENA

CASSETTA COMPLETA DI 1 SET DI QUATTRO PIEDINI

- Fornita montata



■ 07

COD. ART.	DIM. mm
F PA 8552 AD 07	800x600x220 h
Cassetta altezza mm 120	
Capacità litri 49	

COD. ART.	DIM. mm
F PA 8752 AD 07	800x600x270 h
Cassetta altezza mm 170	
Capacità litri 69	

COD. ART.	DIM. mm
F PA 8952 AD 07	800x600x320 h
Cassetta altezza mm 220	
Capacità litri 90	

COD. ART.	DIM. mm
F PA 9352 AD 07	800x600x425 h
Cassetta altezza mm 325	
Capacità litri 130	

COD. ART.	DIM. mm
F PA 9752 AD 07	800x600x530 h
Cassetta altezza mm 430	
Capacità litri 175	

CASSETTA COMPLETA DI 1 SET DI QUATTRO PIEDINI E 1 COPPIA TRVERSE DI COLLEGAMENTO

- Fornita montata



■ 07

COD. ART.	DIM. mm
F PA 8552 AE 07	800x600x245 h
Cassetta altezza mm 120	
Capacità litri 49	

COD. ART.	DIM. mm
F PA 8752 AE 07	800x600x295 h
Cassetta altezza mm 170	
Capacità litri 69	

COD. ART.	DIM. mm
F PA 8952 AE 07	800x600x345 h
Cassetta altezza mm 220	
Capacità litri 90	

COD. ART.	DIM. mm
F PA 9352 AE 07	800x600x450 h
Cassetta altezza mm 325	
Capacità litri 130	

COD. ART.	DIM. mm
F PA 9752 AE 07	800x600x555 h
Cassetta altezza mm 430	
Capacità litri 175	

CASSETTA COMPLETA DI 1 SET DI QUATTRO RUOTE GIREVOLI IN GOMMA ANTISTATICA Ø 100 mm

- Fornita montata



■ 07

COD. ART.	DIM. mm
F PA 8552 AF 07	800x600x245 h
Cassetta altezza mm 120	
Capacità litri 49	

COD. ART.	DIM. mm
F PA 8752 AF 07	800x600x295 h
Cassetta altezza mm 170	
Capacità litri 69	

COD. ART.	DIM. mm
F PA 8952 AF 07	800x600x345 h
Cassetta altezza mm 220	
Capacità litri 90	

COD. ART.	DIM. mm
F PA 9352 AF 07	800x600x450 h
Cassetta altezza mm 325	
Capacità litri 130	

COD. ART.	DIM. mm
F PA 9752 AF 07	800x600x555 h
Cassetta altezza mm 430	
Capacità litri 175	



- I 4 piedini permettono, rientrando nella cassetta sottostante, l'impilamento delle cassette



- Le 2 traverse di collegamento permettono la sovrapposizione delle cassette



- Le 4 ruote permettono, rientrando nella cassetta sottostante, l'impilamento delle cassette

NERO
F. 07

LEGENDA ■

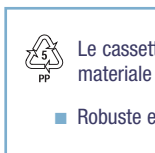
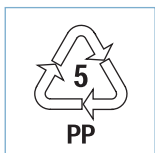

Le cassette contrassegnate con questo simbolo sono realizzate in materiale plastico completamente riciclabile.

- Robuste e resistenti ad alte e basse temperature



PER CASSETTE = 400x300 / 600x400 mm

SERIE STORAGE ESD ATHENA

DIVISORI PER CASSETTE 400x300 / 600x400



PER CASSETTE 400x300



■ 07

COD. ART.

DIM. mm

F PP 4052 00 07 256x178x90 h

Per cassette 400x300

N. compart. 1



■ 07

COD. ART.

DIM. mm

F PP 4552 00 07 256x178x90 h

Per cassette 400x300

N. compart. 2



■ 07

COD. ART.

DIM. mm

F PP 5052 00 07 256x178x90 h

Per cassette 400x300

N. compart. 4

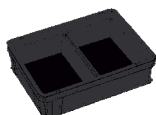

2 ART. F PP 4052 00 07

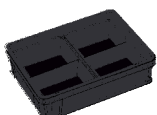

2 ART. F PP 4552 00 07

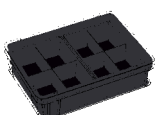

2 ART. F PP 5052 00 07

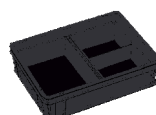

1 ART. F PP 4052 00 07
1 ART. F PP 4552 00 07

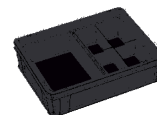

1 ART. F PP 4052 00 07
1 ART. F PP 5052 00 07

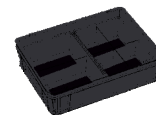

1 ART. F PP 4552 00 07
1 ART. F PP 5052 00 07

PER CASSETTE 600x400



■ 07

COD. ART.

DIM. mm

F PP 6052 00 07 357x278x90 h

Per cassette 600x400

N. compart. 1



■ 07

COD. ART.

DIM. mm

F PP 6552 00 07 357x278x90 h

Per cassette 600x400

N. compart. 2



■ 07

COD. ART.

DIM. mm

F PP 7052 00 07 357x278x90 h

Per cassette 600x400

N. compart. 4

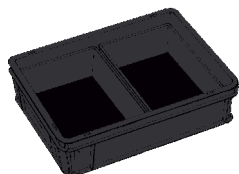

2 ART. F PP 6052 00 07

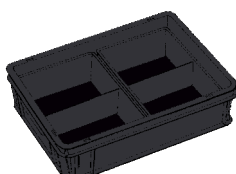

2 ART. F PP 6552 00 07

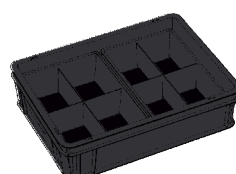

2 ART. F PP 7052 00 07

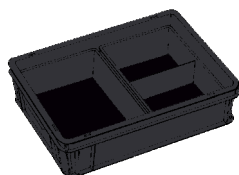

1 ART. F PP 6052 00 07
1 ART. F PP 6552 00 07

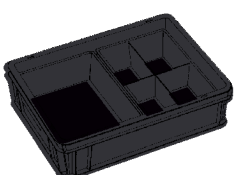

1 ART. F PP 6052 00 07
1 ART. F PP 7052 00 07

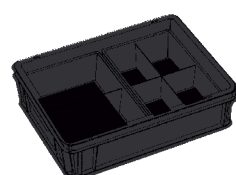

1 ART. F PP 6552 00 07
1 ART. F PP 7052 00 07

■ LEGENDA



Le cassette contrassegnate con questo simbolo sono realizzate in materiale plastico completamente riciclabile.

■ Robuste e resistenti ad alte e basse temperature

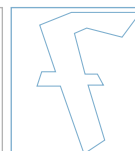
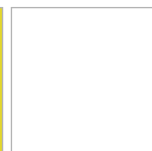

■ NERO
F.....07

SERIE STORAGE ESD ATHENA

DIVISORI A PETTINE CONDUTTIVI

COD. ART.	DIM. mm	PASSO FESSURE mm	PER CASSETTE SERIE
F HP 1320 00 07	255x45	20	400x300
F HP 1420 00 07	355x45	20	400x300 600x400
F HP 1620 00 07	555x45	20	600x400
F HP 1340 00 07	255x70	20	400x300
F HP 1440 00 07	355x70	20	400x300 600x400
F HP 1640 00 07	555x70	20	600x400
F HP 1350 00 07	255x90	20	400x300
F HP 1450 00 07	355x90	20	400x300 600x400
F HP 1650 00 07	555x90	20	600x400
F HP 1360 00 07	255x120	20	400x300
F HP 1460 00 07	355x120	20	400x300 600x400
F HP 1660 00 07	555x120	20	600x400
F HP 1370 00 07	255x180	20	400x300
F HP 1470 00 07	355x180	20	400x300 600x400
F HP 1670 00 07	555x180	20	600x400

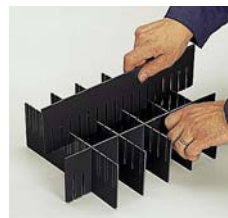
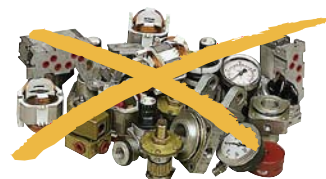
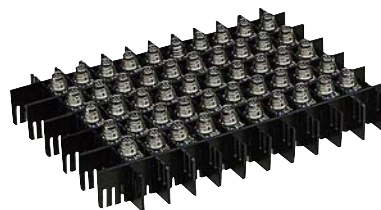

inserimento divisori verticali

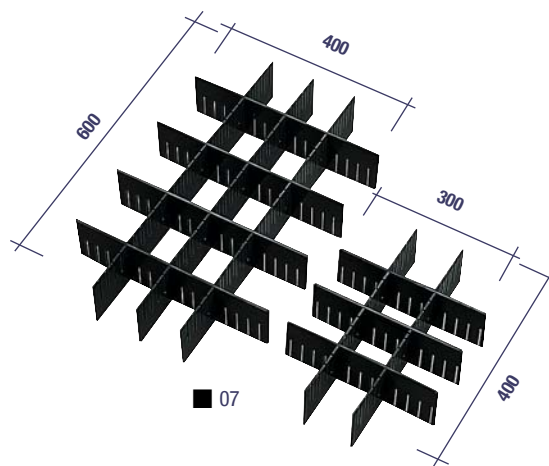
**ART. F HP 5130 00 07**Piano intermedio conduttivo
per cassette serie 400x300
mm 355x255**ART. F HP 5140 00 07**Piano intermedio conduttivo
per cassette serie 600x400
mm 555x355

PIANO A TACCHE PER SCHEDE E CIRCUITI STAMPATI



■ 07

COD. ART.**F PV 5752 00 07****DIM. ESTERNE mm****355x255x14 h**■ NERO
F.....07

LEGENDA ■

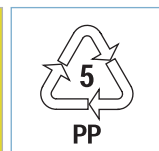

Le cassette contrassegnate con questo simbolo sono realizzate in materiale plastico completamente riciclabile.

- Robuste e resistenti ad alte e basse temperature



PORTA ETICHETTE



inserimento porta etichetta a una finestra



inserimento porta etichetta a due finestre



inserimento etichetta



ART. F PZ 9551 00 07
Porta etichetta

■ 07



ART. F PZ 9751 00 07
Porta etichetta

■ 07

COD. ART.	DIM. ETICHETTA mm	ETICHETTA ARTICOLO	PER CASSETTA ARTICOLO
F PZ 9551 00 07	145x81	F PZ 0920 00 00	F PA 4452 A0 07 F PA 4852 A0 07 F PA 5252 A0 07
F PZ 9751 00 07	210x81	F PZ 0940 00 00	F PA 6452 A0 07 F PA 7652 A0 07

GANCI PER COPERCHI



ART. F PZ 0681 00 13
Gancio per coperchio.
Adatto a tutte le cassette
ad eccezione
dell' Art. F PA 3652 A0 07



■ 99

ART. F PX 0910 00 99
Clip a "U"



■ 99

ART. F PZ 0010 00 99
Molla porta bolle

■ LEGENDA



Le cassette contrassegnate con questo simbolo sono realizzate in materiale plastico completamente riciclabile.

■ Robuste e resistenti ad alte e basse temperature

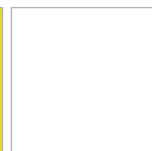

NERO
F. 07

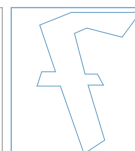

SERIE STORAGE ESD ZEUS - COMPAT

■ 07

**COD. ART.** CAPACITÀ LITRI**F PL 0952 00 07** 0,25

Dim. esterne mm 85/65x95x45 h

Dim. interne mm 63x90x43 h

Peso gr. 44

■ 07

**COD. ART.** CAPACITÀ LITRI**F PM 1752 00 07** 1

Dim. esterne mm 160/140x95x75 h

Dim. interne mm 134x88x65 h

Peso gr. 100

■ 07

**COD. ART.** CAPACITÀ LITRI**F PM 2552 00 07** 3,8

Dim. esterne mm 230/200x140x130 h

Dim. interne mm 191x124x111 h

Peso gr. 340

■ 07

**COD. ART.** CAPACITÀ LITRI**F PM 3352 00 07** 9,4

Dim. esterne mm 350/300x200x145 h

Dim. interne mm 285x182x130 h

Peso gr. 650

■ 07

**COD. ART.** CAPACITÀ LITRI**F PM 4152 00 07** 12,5

Dim. esterne mm 350/300x200x200 h

Dim. interne mm 278x180x187 h

Peso gr. 890

■ 07

**COD. ART.** CAPACITÀ LITRI**F PM 5752 00 07** 20

Dim. esterne mm 500/450x300x145 h

Dim. interne mm 440x278x129 h

Peso gr. 1390

■ 07

**COD. ART.** CAPACITÀ LITRI**F PM 6552 00 07** 28

Dim. esterne mm 500/450x300x200 h

Dim. interne mm 435x281x186 h

Peso gr. 1570

■ 07

**COD. ART.** CAPACITÀ LITRI**F PM 7352 00 07** 42

Dim. esterne mm 500/450x300x300 h

Dim. interne mm 432x280x287 h

Peso gr. 2120

■ 07

**COD. ART.** CAPACITÀ LITRI**F PJ 5752 00 07** 16,2

Dim. esterne mm 450x300x120 h

Dim. interne mm 426x275x106 h

Peso gr. 1010

■ 07

**COD. ART.** CAPACITÀ LITRI**F PJ 2552 00 07** 3,6

Dim. esterne mm 200x140x130 h

Dim. interne mm 186x125x110 h

Peso gr. 300

■ 07

**COD. ART.** CAPACITÀ LITRI**F PJ 3352 00 07** 8,7

Dim. esterne mm 300x200x145 h

Dim. interne mm 284x181x130 h

Peso gr. 570

■ 07

**COD. ART.** CAPACITÀ LITRI**F PJ 6552 00 07** 27

Dim. esterne mm 450x300x200 h

Dim. interne mm 428x277x183 h

Peso gr. 1430

ETICHETTE PER CONTENITORI E CASSETTE

COD. ART.	PER CASSETTE E CONTENITORI ART.	DIM. ETICHETTA SINGOLA mm	N. ETICHETTE PER FOGLIO
F PL 9020 00 00	F PL 0952 00 07	49x11	80
F PL 9040 00 00	F PM 1752 00 07	75x20	35
F PL 9100 00 00	F PM 2552 00 07	104x33	16
F PL 9060 00 00	F PM 3352 00 07 / F PM 5752 00 07	77x31	18
F PL 9080 00 00	F PM 4152 00 07 / F PM 6552 00 07 / F PM 7352 00 07	77x42	12
F PL 9140 00 00	F PJ 5752 00 07	189x82	3
F PL 9160 00 00	F PJ 6552 00 07	189x85	3

NERO
F. 07

LEGENDA



Le cassette contrassegnate con questo simbolo sono realizzate in materiale plastico completamente riciclabile.

- Robuste e resistenti ad alte e basse temperature

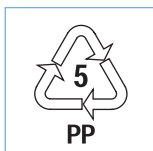
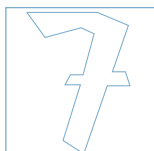

CASSETTE MULTIBOX SERIE F PK

SERIE STORAGE ESD MULTIBOX

CASSETTE MULTIBOX SERIE F PK

Le cassette serie Multibox F PK sono disponibili in quattro misure diverse e sono realizzate in polipropilene conduttivo nero.

Sono stampate ad iniezione con uno speciale composto conduttivo "FAMI 408 L" che ha la peculiarità d'impedire la formazione di cariche elettrostatiche oppure di scaricare quelle già presenti (vedi pagina G70). Le cassette sono disponibili di serie soltanto con larghezza di 160 mm e altezza di 100 mm ma in 4 profondità differenti: 300, 400, 500 e 650 mm.

È possibile suddividere le cassette in lunghezza con dei divisori mobili fino ad un massimo di 11 scomparti.

Le cassette possono essere dotate di maniglia multiuso con le seguenti funzioni: 1. trasporto manuale; 2. estrazione manuale dagli scaffali; 3. impediscono alla cassetta di cadere dallo scaffale quando è parzialmente estratta.

La parte anteriore delle cassette e i divisori sono predisposti per l'inserimento di etichette d'identificazione.

Divisori, maniglie ed etichette devono essere tutti ordinati a parte.



■ 07



■ 07



■ 07



COD. ART.

DIM. mm

F PK 1052 00 07 300x160x100 h

Dim. esterne mm 300x160x100 h

Dim. interne mm 260x135x89 h

Q.tà max di divisori 4 pz
trasversali inseribili ART. F PK 7352 00 07

COD. ART.

DIM. mm

F PK 2052 00 07 400x160x100 h

Dim. esterne mm 400x160x100 h

Dim. interne mm 358x135x90 h

Q.tà max di divisori 6 pz
trasversali inseribili ART. F PK 7352 00 07

COD. ART.

DIM. mm

F PK 3552 00 07 500x160x100 h

Dim. esterne mm 500x160x100 h

Dim. interne mm 460x135x89 h

Q.tà max di divisori 8 pz
trasversali inseribili ART. F PK 7352 00 07

■ 07

COD. ART.

DIM. mm

F PK 5052 00 07 650x160x100 h

Dim. esterne mm 650x160x100 h

Dim. interne mm 610x135x89 h

Q.tà max di divisori 11 pz
trasversali inseribili ART. F PK 7352 00 07

MANIGLIA PER MULTIBOX



Maniglia dim. mm 120x80 h

COD. ART. F PK 6352 00 07

F PK 1052 00 07
F PK 2052 00 07
F PK 3552 00 07
F PK 5052 00 07

Per cassette ART.

DIVISORIO PER MULTIBOX



Divisorio dim. mm 145x90 h

COD. ART. F PK 7352 00 07

F PK 1052 00 07
F PK 2052 00 07
F PK 3552 00 07
F PK 5052 00 07

Per cassette ART.

ETICHETTE PER CASSETTE

COD. ART.

PER CASSETTE
ART.DIM. ETICHETTA
SINGOLA mmN. ETICHETTE
PER FOGLIO**F PK 9580 00 00**

F PK 1052 00 07
F PK 2052 00 07
F PK 3552 00 07
F PK 5052 00 07

121x44

8

ETICHETTE PER DIVISORI

COD. ART.

PER DIVISORI
ART.DIM. ETICHETTA
SINGOLA mmN. ETICHETTE
PER FOGLIO**F PK 9560 00 00**

F PK 7352 00 07

121x24

16



■ LEGENDA



Le cassette contrassegnate con questo simbolo sono realizzate in materiale plastico completamente riciclabile.

- Robuste e resistenti ad alte e basse temperature



PP



■ NERO
F. 07



SERIE STORAGE ESD

MARCHIATURA PERSONALIZZATA

Le cassette conduttive diventano un ottimo veicolo pubblicitario, data la possibilità di imprimere a caldo o in rilievo il logo dell'azienda su uno o più lati.



■ 07



stampa a caldo

TAPPETI CONDUTTIVI ANTISDRUCCIOLEVOLI

Il particolare sistema di incastrò degli elementi consente un facile montaggio, agevolando inoltre la pulizia e la manutenzione. Questi tappeti sono particolarmente adatti al settore elettronico oltre che per l'industria degli esplosivi.

Il materiale impiegato è polietilene conduttivo a bassa densità.

Caratteristiche:

- Antisdrucchiolo
- Facilmente lavabile
- Fonoassorbente
- Morbido
- Conduttivo



versione chiusa

■ 07



versione aperta

■ 07

COD. ART.	DIM. mm	DESCRIZIONE
F PX 1542 00 07	800x400x25	Tappeto
F PX 0242 00 07	400x120x25	Raccordo
F PX 0742 00 07	120x120x25	Angolo

COD. ART.	DIM. mm	DESCRIZIONE
F PX 2542 00 07	800x400x25	Tappeto
F PX 0242 00 07	400x120x25	Raccordo
F PX 0742 00 07	120x120x25	Angolo

■ NERO
F. 07

INFO ■

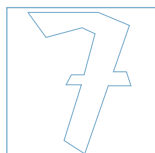

www.famispa.com





SERIE STORAGE ESD

■ SISTEMI DI SUDDIVISIONE (MEGAPRINT® – MINIPRINT®)

FAMI ha progettato e realizzato una gamma completa di prodotti per risolvere in maniera razionale e sicura tutti i problemi connessi con l'industria elettronica.

I prodotti FAMI destinati a questo settore sono caratterizzati dalla linearità e dalla modularità con soluzioni moderne per i settori della produzione, del magazzinaggio, del trasporto, della riparazione e manutenzione delle schede a circuito stampato oltre che dei vari componenti elettronici.

Per la realizzazione dei suoi prodotti FAMI impiega materiali di alta qualità che garantiscono una protezione totale contro le cariche elettrostatiche e i danni di natura meccanica.

I sistemi porta schede FAMI si sono rivelati strumenti ideali nel settore elettromeccanico, dell'elettronica, minerario oltre che negli stabilimenti per la produzione di esplosivi.

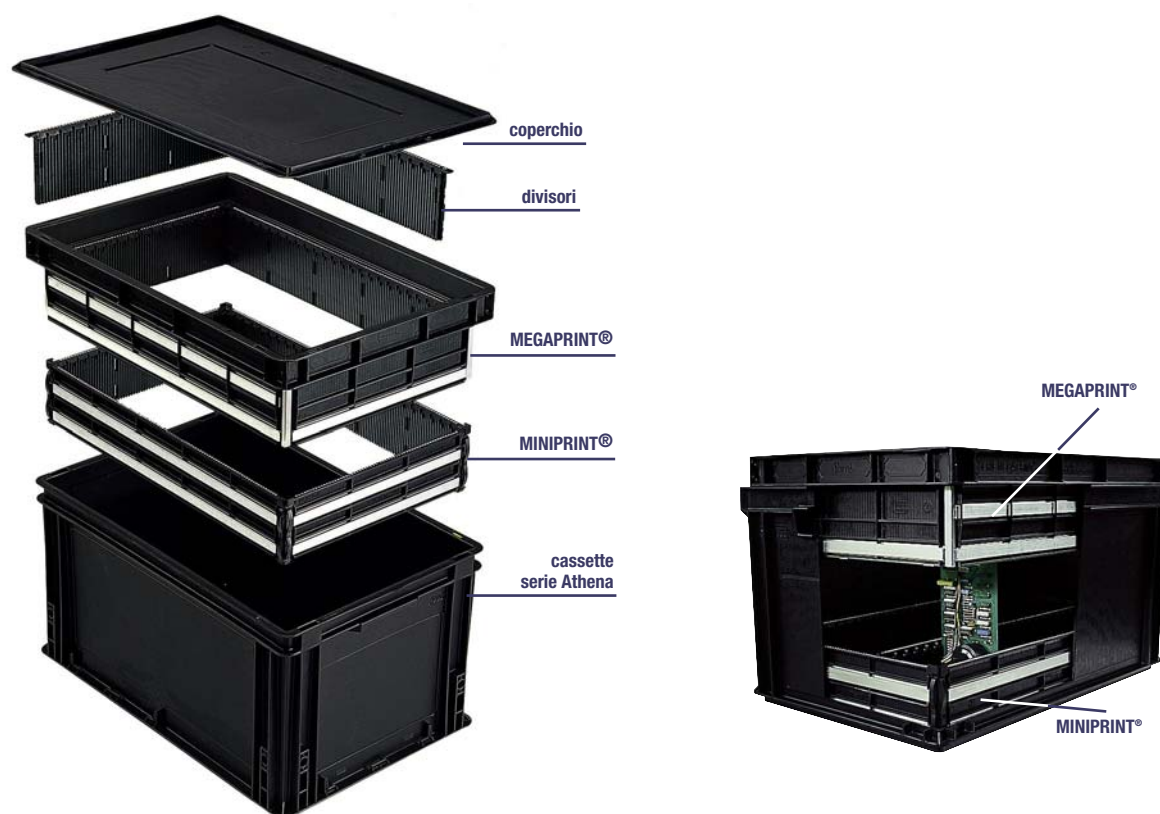

NERO
F... ..07

LEGENDA ■



Le cassette contrassegnate con questo simbolo sono realizzate in materiale plastico completamente riciclabile.

- Robuste e resistenti ad alte e basse temperature



TABELLA DELLE SUDDIVISIONI



Per una scelta più facile e rapida dei divisori da usare con i sistemi Megaprint® e Miniprint®, consigliamo di riferirsi alle tabelle per la suddivisione che specificano i punti di inserimento in base alla misura delle schede da inserire.

DIVISORI

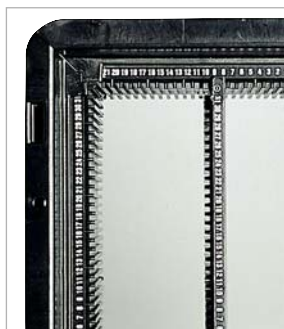

Dati tecnici del sistema standard	
■ Larghezza delle scanalature2,5 mm
■ Profondità delle scanalature3,0 mm
■ Passo delle scanalature5,08 mm
■ Suddivisione minima del sistema1,7 mm



Per facilitare l'inserimento dei divisori e delle schede nei sistemi Megaprint® e Miniprint®, le scanalature hanno un'identificazione numerica. Il numero attribuito a ciascuna scanalatura corrisponde esattamente al numero della stessa scanalatura sul lato opposto.

La suddivisione dei sistemi Megaprint® e Miniprint® si adatta perfettamente alla gran varietà di misure esistenti per le schede a circuito stampato, anche perché i divisori sono disponibili in tre varianti:

- divisorio per distanza normale
- divisorio per distanza meno
- divisorio per distanza più

Con questo sistema le distanze tra divisori si possono variare con un passo di 1,7 mm.



■ LEGENDA



Le cassette contrassegnate con questo simbolo sono realizzate in materiale plastico completamente riciclabile.

- Robuste e resistenti ad alte e basse temperature

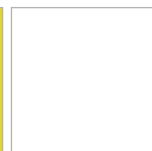

NERO
F. 07

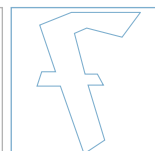

SERIE STORAGE ESD

MEGAPRINT® 400x300

Il sistema Megaprint® 400x300 è ideale nel settore della produzione e del magazzinaggio di schede elettroniche a circuito stampato. Il sistema è stato pensato e realizzato in particolare per i cicli di produzione di schede a circuiti stampati, dalla progettazione fino alla produzione finale.

Il sistema consiste di quattro pareti rigide unite sui lati esterni con profili rinforzati in alluminio per conferire maggior robustezza e perpendicolarità.

Sui lati interni presentano delle scanalature per la collocazione delle schede.

Questo sistema unito ai divisori offre infinite soluzioni di contenimento di schede a circuito stampato con larghezza massima di 235 mm.

Il Megaprint® 400x300 viene inserito sul bordo superiore delle cassette standard 400x300.

Dati tecnici del sistema standard

- Larghezza delle scanalature 2,5 mm
- Profondità delle scanalature 3,0 mm
- Passo delle scanalature 5,08 mm
- Suddivisione minima del sistema 1,7 mm



■ 07

COD. ART.	DIM. esterne mm	DIM. interne mm	SCANALATURE			SUDDIVISIONE minima del sistema mm	PASSO scanalature	ADATTO per cassette
			largh. mm	profon. mm	passo mm			
F PV 7752 00 07	400x300x140	335x235x140	2,5	3,0	5,08	1,7	4 lati da 5,08 mm	F PA 4052 A0 07 F PA 4452 A0 07 F PA 4852 A0 07 F PA 5252 A0 07

MINIPRINT® 400x300

Il sistema Miniprint® 400x300 ha le stesse caratteristiche tecniche del sistema Megaprint®, con la particolarità che va inserito all'interno, sul fondo delle cassette conduttive FAMI da 400x300 mm ed è adatto al contenimento di schede con larghezza massima di 235 mm.

Per schede particolarmente alte, il sistema Miniprint® viene combinato con Megaprint® ottenendo in tal modo una scanalatura più lunga e dunque offrendo maggior sicurezza per le schede inserite.

Dati tecnici del sistema standard

- Larghezza delle scanalature 2,5 mm
- Profondità delle scanalature 3,0 mm
- Passo delle scanalature 5,08 mm
- Suddivisione minima del sistema 1,7 mm



■ 07

COD. ART.	DIM. esterne mm	DIM. interne mm	SCANALATURE			SUDDIVISIONE minima del sistema mm	PASSO scanalature	ADATTO per cassette
			largh. mm	profon. mm	passo mm			
F PV 7252 00 07	360x260x98	335x235x98	2,5	3,0	5,08	1,7	4 lati da 5,08 mm	F PA 4052 A0 07 F PA 4452 A0 07 F PA 4852 A0 07 F PA 5252 A0 07

■ NERO
F. 07

LEGENDA ■



Le cassette contrassegnate con questo simbolo sono realizzate in materiale plastico completamente riciclabile.

- Robuste e resistenti ad alte e basse temperature



CON IL MEGAPRINT® L'ALTEZZA DELLA CASSETTA VIENE AUMENTATA DI 44 mm

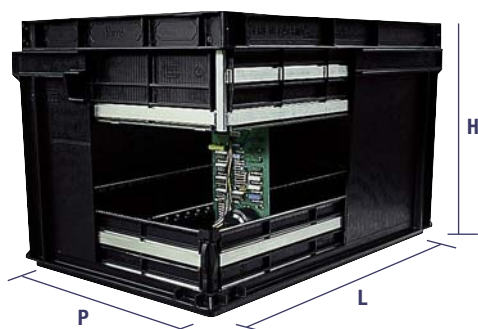

COD. ART.	DIM. ESTERNE cassette + Megaprint® mm	POSSIBILITÀ DI INERIMENTO SCHEDE	
		largh. mm	profon. mm
F PA 4052 A0 07	400x300x164	235	150
F PA 4852 A0 07	400x300x264	235	250
F PA 5252 A0 07	400x300x369	235	355

Esempio di Megaprint® combinato con Miniprint® usato per dare maggior sostegno a schede elettroniche particolarmente alte.

DIVISORI PER CASSETTE 400x300

I sistemi Megaprint® e Miniprint® si possono suddividere in modo logico e preciso con una serie di divisori dalle particolari caratteristiche.

Ciò consente di utilizzare il sistema in maniera completa e flessibile poiché vi si possono inserire schede di varie misure.

I divisori sono disponibili in tre varianti con un passo minimo di suddivisione di 1,7 mm.

Le tre varianti sono: distanza normale, meno e più. I divisori sono rinforzati da profili in alluminio.

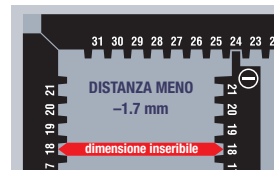
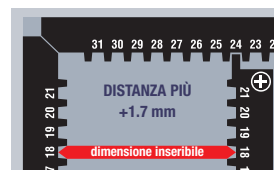
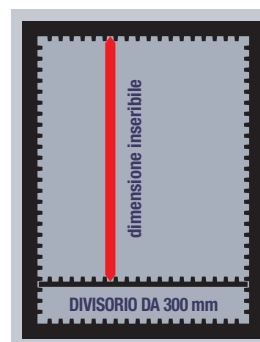
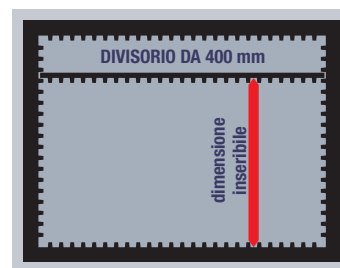

COD. ART.	DISTANZA	DIVISORIO da mm	DIM. ESTERNE mm
F PV 0752 00 07	meno	400	335x98
F PV 0852 00 07	normale	400	335x98
F PV 0952 00 07	più	400	335x98



COD. ART.	DISTANZA	DIVISORIO da mm	DIM. ESTERNE mm
F PV 0252 00 07	meno	300	235x98
F PV 0352 00 07	normale	300	235x98
F PV 0452 00 07	più	300	235x98

LEGENDA



Le cassette contrassegnate con questo simbolo sono realizzate in materiale plastico completamente riciclabile.

■ Robuste e resistenti ad alte e basse temperature



NERO
F. 07

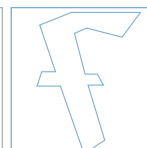

SERIE STORAGE ESD

MEGAPRINT® 600x400

Il sistema Megaprint® 600x400 ha caratteristiche tecniche uguali a quelle del Megaprint® 400x300, e viene impiegato per contenere schede della dimensione massima di 535 mm.

Può essere inserito nelle cassette conduttive serie Athena da 600x400 mm di diverse altezze.

Dati tecnici del sistema standard

- Larghezza delle scanalature 2,5 mm
- Profondità delle scanalature 3,0 mm
- Passo delle scanalature 5,08 mm
- Suddivisione minima del sistema 1,7 mm



■ 07



COD. ART.	DIM. esterne mm	DIM. interne mm	SCANALATURE			SUDDIVISIONE minima del sistema mm	PASSO scanalature	ADATTO per cassette
			largh. mm	profon. mm	passo mm			
F PV 7952 00 07	600x400x140	535x335x140	2,5	3,0	5,08	1,7	4 lati da 5,08 mm	F PA 6052 A0 07 F PA 6452 A0 07 F PA 6852 A0 07 F PA 7652 A0 07 F PA 8052 B0 07

MINIPRINT® 600x400

Il sistema Miniprint® 600x400 ha caratteristiche tecniche uguali a quelle del Miniprint® 400x300, e viene impiegato per contenere schede della dimensione massima di 535 mm.

Può essere inserito nel sistema FAMI di cassette conduttive serie Athena da 600x400 mm di diverse altezze.

Dati tecnici del sistema standard

- Larghezza delle scanalature 2,5 mm
- Profondità delle scanalature 3,0 mm
- Passo delle scanalature 5,08 mm
- Suddivisione minima del sistema 1,7 mm



■ 07



COD. ART.	DIM. esterne mm	DIM. interne mm	SCANALATURE			SUDDIVISIONE minima del sistema mm	PASSO scanalature	ADATTO per cassette
			largh. mm	profon. mm	passo mm			
F PV 7452 00 07	560x360x98	535x335x98	2,5	3,0	5,08	1,7	4 lati da 5,08 mm	F PA 6052 A0 07 F PA 6452 A0 07 F PA 6852 A0 07 F PA 7652 A0 07 F PA 8052 B0 07

■ NERO
F. 07

LEGENDA ■



Le cassette contrassegnate con questo simbolo sono realizzate in materiale plastico completamente riciclabile.

- Robuste e resistenti ad alte e basse temperature



CON IL MEGAPRINT® L'ALTEZZA DELLA CASSETTA VIENE AUMENTATA DI 44 mm

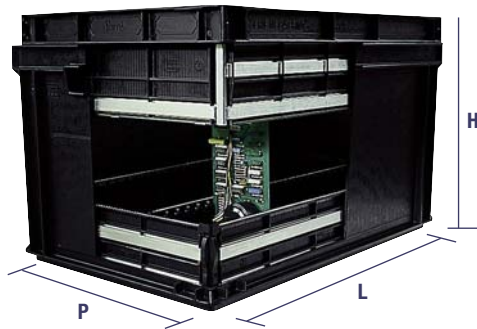

COD. ART.	DIM. ESTERNE cassette + Megaprint® mm	POSSIBILITÀ DI INERIMENTO SCHEDE	
		largh. mm	profon. mm
F PB 6852 A0 07	600x400x264	535	250
F PA 7652 A0 07	600x400x369	535	355
F PA 8052 B0 07	600x400x474	535	455

Esempio di Megaprint® combinato con Miniprint® usato per dare maggior sostegno a schede elettroniche particolarmente alte.

DIVISORI PER CASSETTE 600x400

I sistemi Megaprint® e Miniprint® si possono suddividere in modo logico e preciso con una serie di divisori dalle particolari caratteristiche.

Ciò consente di utilizzare il sistema in maniera completa e flessibile poiché vi si possono inserire schede di varie misure.

I divisori sono disponibili in tre varianti con un passo minimo di suddivisione di 1,7 mm.

Le tre varianti sono: distanza normale, meno e più. I divisori sono rinforzati da profili in alluminio.

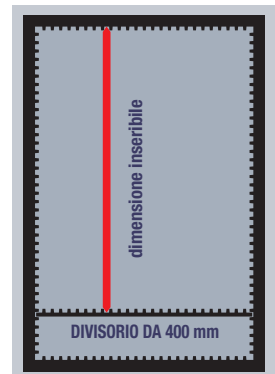
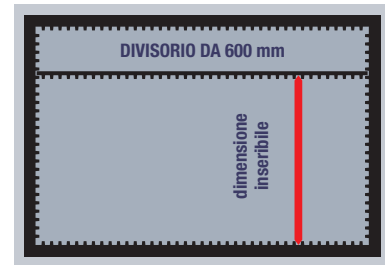

07

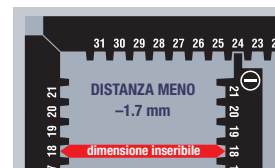
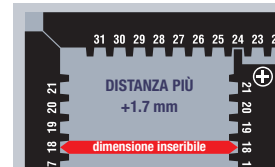

COD. ART.	DISTANZA	DIVISORIO da mm	DIM. ESTERNE mm
F PV 0752 00 07	meno	400	335x98
F PV 0852 00 07	normale	400	335x98
F PV 0952 00 07	più	400	335x98

COD. ART.	DISTANZA	DIVISORIO da mm	DIM. ESTERNE mm
F PV 1752 00 07	meno	600	535x98
F PV 1852 00 07	normale	600	535x98
F PV 1952 00 07	più	600	535x98

LEGENDA



Le cassette contrassegnate con questo simbolo sono realizzate in materiale plastico completamente riciclabile.

- Robuste e resistenti ad alte e basse temperature



NERO
F. 07

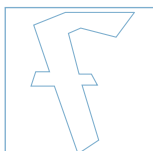

SERIE STORAGE ESD

■ SISTEMA PER ROBOTICA

Le caratteristiche sperimentate del sistema Megaprint® sono state ulteriormente sviluppate con l'introduzione di una versione per Robotica. Questo sistema è stato progettato per essere impiegato in sistemi completamente automatizzati, oltre che per migliorare drasticamente i tempi di inserimento schede in ambienti produttivi ad alta manualità.

Dati tecnici del sistema per robotica

- Larghezza delle scanalature 3,5 mm
- Profondità delle scanalature 3,0 mm
- Passo delle scanalature 15,24 mm
- Suddivisione minima del sistema 1,7 mm

I punti di inserimento hanno delle scanalature ad angolo per migliorare l'inserimento.

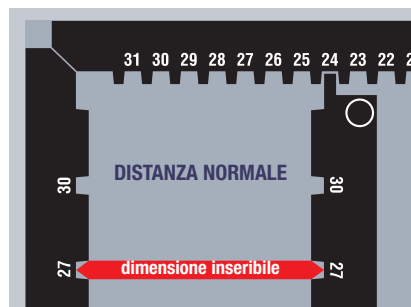
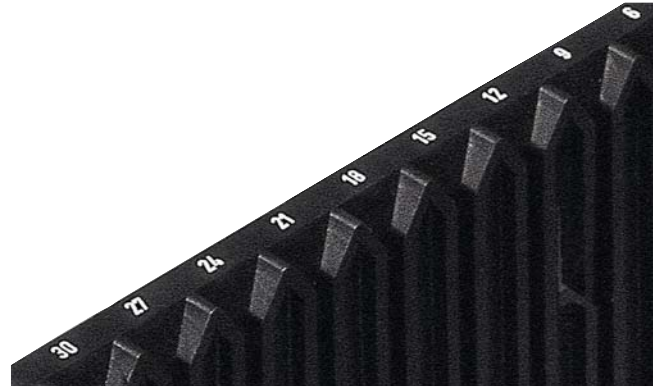

■ NERO
F. 07

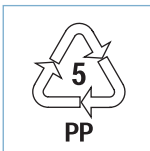
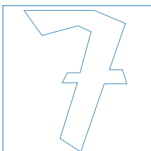

LEGENDA ■



Le cassette contrassegnate con questo simbolo sono realizzate in materiale plastico completamente riciclabile.

- Robuste e resistenti ad alte e basse temperature



MEGAPRINT® / MINIPRINT® – 400x300



■ 07

MEGAPRINT® 400x300
ART. F PV 8752 00 07



■ 07

MINIPRINT® 400x300
ART. F PV 8252 00 07

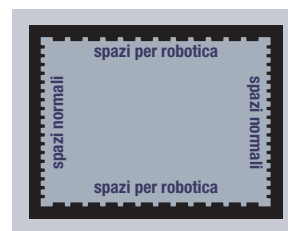

COD. ART.	DIM. esterne mm	DIM. interne mm	SCANALATURE			SUDDIVISIONE minima del sistema mm	PASSO scanalature	ADATTO per cassette
			largh. mm	profon. mm	passo mm			
F PV 8752 00 07 Megaprint® robotica	400x300x140	335x235x140	3,5	3,0	15,24	1,7	2 lati da 5,08 mm	F PA 4052 A0 07 F PA 4452 A0 07 F PA 4852 A0 07
F PV 8252 00 07 Miniprint® robotica	360x260x98	335x235x98					2 lati da 15,24 mm	F PA 5252 A0 07

MEGAPRINT® / MINIPRINT® – 600x400



■ 07

MEGAPRINT® 600x400
ART. F PV 8952 00 07

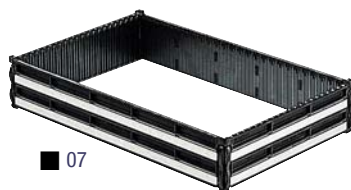

■ 07

MINIPRINT® 600x400
ART. F PV 8452 00 07

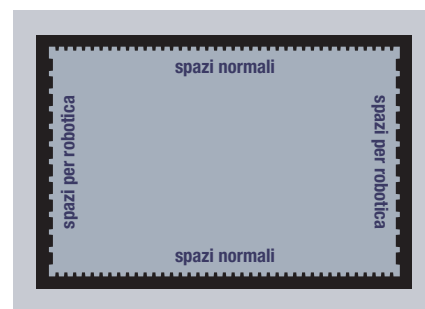

COD. ART.	DIM. esterne mm	DIM. interne mm	SCANALATURE			SUDDIVISIONE minima del sistema mm	PASSO scanalature	ADATTO per cassette
			largh. mm	profon. mm	passo mm			
F PV 8952 00 07 Megaprint® robotica	600x400x140	535x335x140	3,5	3,0	15,24	1,7	2 lati da 5,08 mm	F PA 6052 A0 07 F PA 6452 A0 07 F PB 6852 A0 07
F PV 8452 00 07 Miniprint® robotica	560x360x98	535x335x98					2 lati da 15,24 mm	F PA 7652 A0 07 F PA 8052 B0 07

DIVISORI PER ROBOTICA

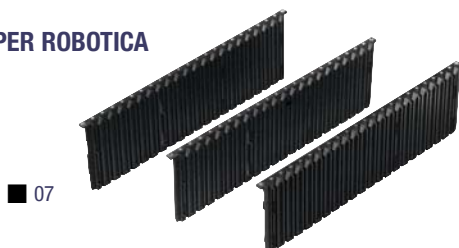

■ 07

COD. ART.	DISTANZA	DIVISORIO da mm	DIM. ESTERNE mm
F PV 2252 00 07	meno	400	335x98
F PV 2352 00 07	normale	400	335x98
F PV 2452 00 07	più	400	335x98

■ LEGENDA



Le cassette contrassegnate con questo simbolo sono realizzate in materiale plastico completamente riciclabile.

■ Robuste e resistenti ad alte e basse temperature



■ NERO
F. 07

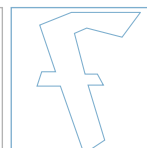

SERIE STORAGE ESD

TELAI PORTA SCHEDE

I telai porta schede costituiscono parte integrante dei sistemi porta schede FAMI e sono impiegati per la produzione, magazzino e trasporto di schede a circuiti stampati. Sostanzialmente si compongono di due pareti laterali e di una parete fissa centrale e guide in alluminio. Questi telai si possono inserire nelle cassette oppure si possono usare come sistemi indipendenti. Oltre alle dimensioni standard di inserimento nella cassetta, il sistema offre la possibilità di avere misure diverse a seconda della lunghezza delle guide. I telai porta schede si possono usare in verticale, in orizzontale o in piano inoltre, se hanno le stesse dimensioni, si possono sovrapporre.

Sempre che il telaio sia compatibile, la precisione della soluzione è tale da consentirne l'utilizzo sia nelle applicazioni manuali che robotizzate.



COPPIA GUIDE IN ALLUMINIO

COD. ART.

DIM. mm

F PV 9110 00 00

152x53

F PV 9120 00 00

252x53

F PV 9140 00 00

352x53

F PV 9160 00 00

552x53



I nostri telai porta schede rappresentano un eccellente sistema per maneggiare schede elettroniche. Realizzati in polipropilene copolimero conduttivo stampato ad iniezione con valore elettrico $10^4\Omega$, si possono usare a contatto con la maggior parte dei solventi e fino ad una temperatura massima di 100°C .

La particolare flessibilità del sistema di bloccaggio consente il movimento per l'intera lunghezza delle guide laterali rinforzate in alluminio.

PARETE COMPLETA DI BLOCCAGGI



ART. F PV 6452 00 07
Parete laterale

ART. F PV 6852 00 07
Parete centrale

ART. F PV 6252 00 07
Parete laterale



ART. F PV 9010 00 07

Set di 4 pezzi completo
di viti e dadi

COD. ART.

DIM.
mm

numero

SCANALATURE

largh. mm

profon. mm

passo mm

F PV 6452 00 07

350x30x190

22

2,5

3,0

15,3

F PV 6852 00 07

350x35x190

22+22

2,5

3,0

15,3

F PV 6252 00 07

250x30x95

15

2,5

3,0

15,3



particolare delle pareti laterali



particolare del bloccaggio



fissaggio pareti laterali

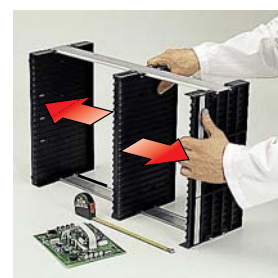

spostamento del divisorio centrale

NERO
F. 07

LEGENDA



Le cassette contrassegnate con questo simbolo sono realizzate in materiale plastico completamente riciclabile.

- Robuste e resistenti ad alte e basse temperature

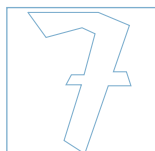

ESEMPIO DI SISTEMI PORTA-SCHEDE

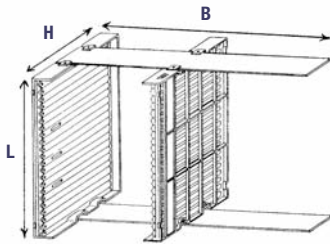

F PV 9110 01 00, F PV 9140 01 00, F PV 9120 01 00 e F PV 9160 01 00

Tutti i telai porta schede sono dotati di serie di una guida di rinforzo in alluminio per garantire una maggior rigidità.

Il profilo scanalato delle pareti porta schede è largo 2,5 mm e profondo 3,0 mm con suddivisioni di 15,3 mm di passo. Ciascuna parete è dotata di un sistema di numerazione stampato per il corretto posizionamento delle schede oltre che di un bordo ferma schede. Tutti i componenti si possono acquistare separatamente, inoltre le guide in alluminio sono disponibili fino a 1,5 m di lunghezza per consentire una maggiore flessibilità.

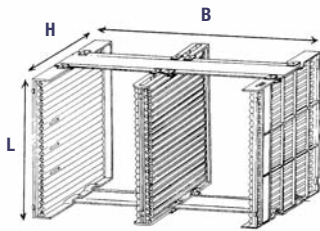

F PV 9120 02 00 e F PV 9160 02 00

Questo sistema offre le stesse soluzioni proposte dai modelli F PV 9110 01 00, F PV 9140 01 00, F PV 9120 01 00 e F PV 9160 01 00.

Avendo però in più una parete centrale con scanalature sui due lati (ART. F PV 6852 00 07), offre una maggior capienza rispetto ad altri sistemi che invece devono abbinare due singole pareti per ottenere lo stesso risultato. Le cassette conduttive di serie per il contenimento di questi porta schede sono disponibili in varie profondità per adattarsi ai diversi modelli esistenti.

COD. ART.	DIM. totali mm	CAPIENZA MAX. schede elettroniche mm	SCANALATURA per schede elettroniche	ADATTO per contenitori	COMPONENTI
F PV 9110 01 00	250x150x95	135x105	15	F PA 2452 A0 07	2x F PV 6252 00 07 1x F PV 9110 00 00 150 mm
F PV 9140 01 00	250x350x95	335x150	15	F PA 4052 A0 07 F PA 4452 A0 07	2x F PV 6252 00 07 1x F PV 9140 00 00 350 mm
F PV 9120 01 00	350x250x190	235x300	21	F PA 4852 A0 07 F PA 5252 A0 07	2x F PV 6452 00 07 1x F PV 9120 00 00 250 mm
F PV 9160 01 00	350x550x190	535x400	21	F PB 6852 A0 07 F PA 7652 A0 07 F PA 8052 B0 07	2x F PV 6452 00 07 1x F PV 9160 00 00 550 mm
F PV 9120 02 00	350x250x190	95x300	42	F PA 4852 A0 07 F PA 5252 A0 07	2x F PV 6452 00 07 1x F PV 6852 00 07 1x F PV 9120 00 00 250 mm
F PV 9160 02 00	350x550x190	2545x400	42	F PB 6852 A0 07 F PA 7652 A0 07 F PA 8052 B0 07	2x F PV 6452 00 07 1x F PV 6852 00 07 1x F PV 9160 00 00 550 mm

I telai porta schede sono inseribili nelle cassette conduttive serie Athena 600x400 e 400x300 mm.



telaio in posizione orizzontale



telaio in posizione verticale

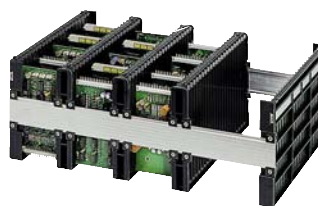

telaio in posizione piana



■ LEGENDA



Le cassette contrassegnate con questo simbolo sono realizzate in materiale plastico completamente riciclabile.

■ Robuste e resistenti ad alte e basse temperature



NERO
F. 07

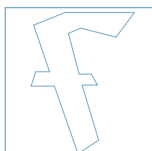

SERIE STORAGE MAT

■ OTTIMA ADERENZA AL PAVIMENTO



Il particolare disegno a rilievo della parte superiore è stato progettato con funzione antiscivolo garantendo la massima aderenza anche in presenza di umidità.



I tappeti antisdrucchio sono adatti ad alloggiare in totale sicurezza cavi elettrici posti a pavimento.

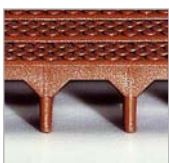

La particolare struttura della parte inferiore permette al tappeto di sopportare anche carichi pesanti.



Raccordi e angoli "a scivolo" aumentano la sicurezza nell'utilizzo da parte dell'operatore con carrello, agevolano lo scorrimento delle ruote e migliorano l'aspetto visivo antinfortunistico.



Tutte le parti possono essere unite e rimosse in modo semplice e rapido grazie all'apposito sistema di aggancio.

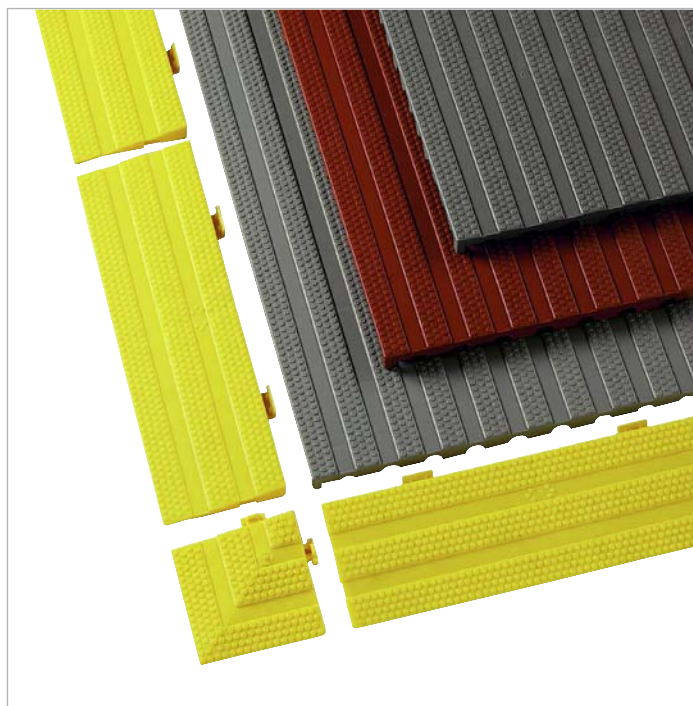

GRIGIO
F. 01

ROSSO MATTONE
F. 06

LEGENDA ■



I tappeti e i componenti sono realizzati in materiale plastico completamente riciclabile.



DIMENSIONI = 800x400 mm

TAPPETO ANTISDRUCCIOLO CHIUSO



COD. ART.

DIM. mm

F PX 1541 00 01

F PX 1541 00 06

800x400x25 h

TAPPETO ANTISDRUCCIOLO APERTO

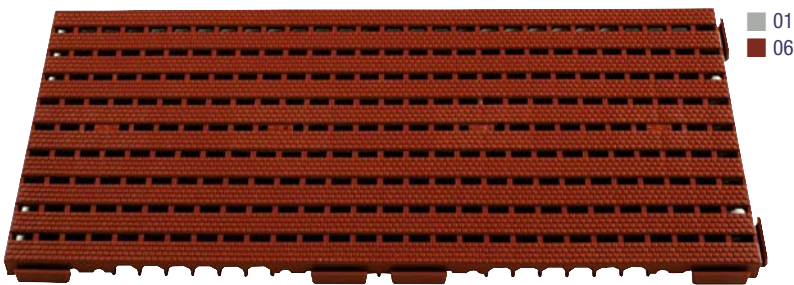

COD. ART.

DIM. mm

F PX 2541 00 01

F PX 2541 00 06

800x400x25 h

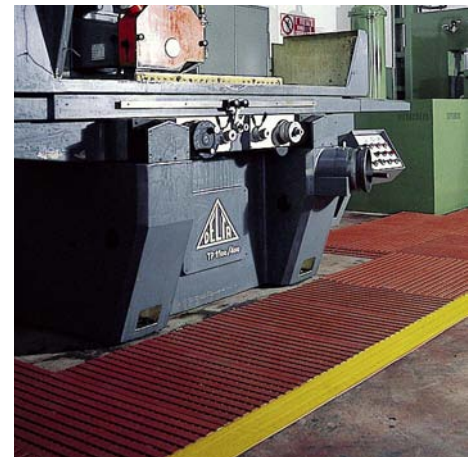

RACCORDO PER TAPPETO



05

COD. ART. F PX 0241 00 05

Dimensioni mm 400x120

ANGOLO PER TAPPETO



05

COD. ART. F PX 0741 00 05

Dimensioni mm 120x120

CLIPS ZINCATA

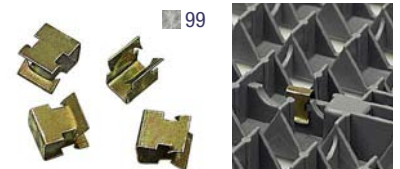

99

COD. ART. F PX 0910 00 99

LEGENDA

ROSSO MATTONO
F. 06GRIGIO
F. 01GIALLO
F. 05ZINCATO
F. 99

I tappeti e i componenti sono realizzati in materiale plastico completamente riciclabile.



PE-LD



SERIE STORAGE BIG STEEL

- VASTA GAMMA DI MODELLI
- ROBUSTI

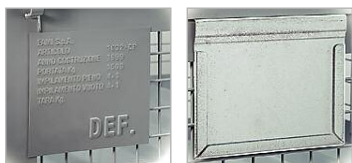

I containers in metallo possono essere corredati di portaetichette, da agganciare al bordo, o di targa di portata, stampata a rilievo, saldata nella posizione richiesta dal cliente.



Lo spazio interno dei containers può essere suddiviso in più scomparti grazie ai pratici divisori in lamiera verniciata.



PALLETS IN LAMIERA

Realizzati in lamiera di acciaio verniciata, i pallets, ideali per la movimentazione del materiale con i carrelli elevatori, si caratterizzano per la maggiore portata e durata nel tempo dei tradizionali pallets in legno.



■ 01

COD. ART.

DIM. mm

F ML 0610 00 01 1000x800x155 h

F ML 0620 00 01 1200x800x155 h

- Portata con carico uniformemente distribuito 2000 kg*

*La portata è stata calcolata con la paletta appoggiata su una superficie uniforme

PALLETS IN PLASTICA

Realizzati in polietilene ad alta densità, sono studiati per garantire la più alta resistenza alle forti sollecitazioni operative. Utilissimi per il trasporto di merce palettizzabile, sono particolarmente leggeri e maneggevoli adattandosi a risolvere tutte le esigenze di movimentazione del carico.

I pallets sono facilmente lavabili garantendo così la massima igiene.



COD. ART.

DIM. mm

F PU 2040 00 13 1200x800x150 h

F PU 3040 00 13 1200x1000x150 h

CONTAINERS IN LAMIERA



■ 01

con portello apribile

COD. ART.

PORTATA kg

DIM. mm

F ML 0321 00 01 700 800x500x600 h



■ 01

COD. ART.

PORTATA kg

DIM. mm

F ML 0320 00 01 700 800x500x600 h

RAL 7000
F. 01

LEGENDA ■

- RICHIEDI CATALOGO

Ulteriori informazioni sui containers e pallets vedi catalogo n. 600 sezione L.



LUNGHEZZA = 800 / 1000 / 1200 mm

SERIE STORAGE BIG STEEL

CONTAINERS A BOCCA DI LUPO



■ 01 ■ 99

COD. ART.	PORTATA kg	DIM. mm
F ML 0510 00 01	1000	800x700x600 h

CONTAINERS IN RETE



■ 01



■ 01

con portello apribile

COD. ART.	PORTATA kg	DIM. mm	FORO MAGLIA
F MM 0400 00 01	1000	1000x800x800 h	60x30 mm
F MM 0410 00 01	1500	1000x800x800 h	40x40 mm

COD. ART.	PORTATA kg	DIM. mm	FORO MAGLIA
F MM 0401 00 01	1000	1000x800x800 h	60x30 mm
F MM 0411 00 01	1500	1000x800x800 h	40x40 mm



■ 01



■ 01

con portello apribile

COD. ART.	PORTATA kg	DIM. mm	FORO MAGLIA
F MM 0420 00 01	1000	1200x800x800 h	60x30 mm
F MM 0430 00 01	1500	1200x800x800 h	40x40 mm

COD. ART.	PORTATA kg	DIM. mm	FORO MAGLIA
F MM 0421 00 01	1000	1200x800x800 h	60x30 mm
F MM 0431 00 01	1500	1200x800x800 h	40x40 mm

■ LEGENDA

■ GRIGIO
F. 01■ ZINCATO
F. 99

■ RICHIEDI CATALOGO

Ulteriori informazioni sui containers e pallets vedi catalogo n. 600 sezione L.



SERIE STORAGE BIG STEEL

LUNGHEZZA = 1000 / 1200 / 1500 mm

CONTAINERS IN RETE ABBATTIBILI



COD. ART.	PORTATA kg	DIM. INGOMBRO mm
F MM 2401 00 01	1200	1000x800x650 h
Dim. interne mm 905x715x455/500 h		
Dim. ingombro abbattuto mm 1000x800x354 h		



COD. ART.	PORTATA kg	DIM. INGOMBRO mm
F MM 2571 00 01	1200	1200x1000x750 h
Dim. interne mm 1100x915x555/600 h		
Dim. ingombro abbattuto mm 1200x1000x354 h		

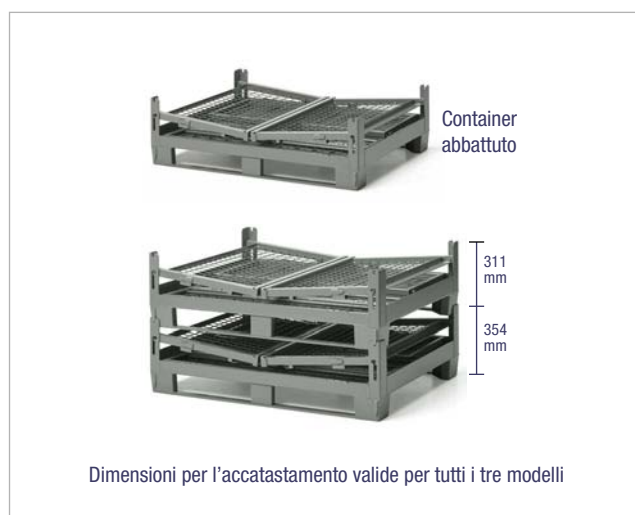

COD. ART.	PORTATA kg	DIM. INGOMBRO mm
F MM 2671 00 01	1200	1500x1000x900 h
Dim. interne mm 1400x915x705/750 h		
Dim. ingombro abbattuto mm 1500x1000x354 h		

GRIGIO
F. 01

INFO ■

www.famispa.com

DIVISORI

SERIE STORAGE BIG STEEL

DIVISORI MOBILI PER CONTAINERS



■ 01



■ 01 ■ 99

COD. ART.

DIM. mm

F MM 0710 00 01**225x760x470 h**

Adatto per articoli:

F MM 0400 - F MM 0401 - F MM 0410 - F MM 0411 -
F MM 0430 - F MM 0431 - F MM 0440 - F MM 0441 -
F ML 0460 - F ML 0461

COD. ART.

DIM. mm

F ML 0710 00 01**630/460x405 h**

Adatto per articoli:

F ML 0510



Esempi di utilizzo dei divisori



■ INFO

GRIGIO
F.01ZINCATO
F.99
www.famispa.com

SERIE STORAGE BIG STEEL



Particolare del fondo

CONTAINERS IN LAMIERA ALTEZZA 690 mm



COD. ART.	PORTATA kg	DIM. INGOMBRO mm
F ML 0430 00 01	1500	1000x800x690 h



COD. ART.	PORTATA kg	DIM. INGOMBRO mm
F ML 0431 00 01	1500	1000x800x690 h

CONTAINER IN LAMIERA ALTEZZA 670 mm



COD. ART.	PORTATA kg	DIM. INGOMBRO mm
F ML 0420 00 01	2000	1000x800x670 h

GRIGIO
F. 01

INFO ■

■ Per i divisori
vedi pag. G97
www.famispa.com

LARGHEZZA = 1000 mm PROFONDITÀ = 800 mm

SERIE STORAGE BIG STEEL

CONTAINERS IN LAMIERA ALTEZZA 800 mm



COD. ART.	PORTATA kg	DIM. INGOMBRO mm
F ML 0440 00 01	1500	1000x800x800 h



COD. ART.	PORTATA kg	DIM. INGOMBRO mm
F ML 0441 00 01	1500	1000x800x800 h

CONTAINERS IN LAMIERA ALTEZZA 800 mm



COD. ART.	PORTATA kg	DIM. INGOMBRO mm
F ML 0450 00 01	1500	1200x800x690 h



COD. ART.	PORTATA kg	DIM. INGOMBRO mm
F ML 0451 00 01	1500	1200x800x690 h



COD. ART.	PORTATA kg	DIM. INGOMBRO mm
F ML 0461 00 01	1500	1200x800x800 h



COD. ART.	PORTATA kg	DIM. INGOMBRO mm
F ML 0460 00 01	1500	1200x800x800 h

■ LEGENDA



■ **RICHIEDI CATALOGO**
Ulteriori informazioni sui containers e pallets vedi catalogo n. 600 sezione L.

GRIGIO
F.....01

SERIE STORAGE BIG STEEL

CONTAINERS RIBALTABILI



■ 01

COD. ART.

PORTATA kg

F ML 0200 00 01

1000

DIM. mm 965x1480x1060 h



■ 01

COD. ART.

PORTATA kg

F ML 0200 10 01

900

DIM. mm 965x1480x1265 h

con 2 ruote in nylon Ø 160 mm, con supporto fisso
e 2 ruote in nylon Ø 160 mm, con supporto girevole
senza freno



Prelevare il container,
per lo scarico del
contenuto,
esclusivamente con
il carrello elevatore



Tirare il cavo d'acciaio
per azionare il
meccanismo
di ribaltamento del
container, rimanendo
obbligatoriamente
seduti sul carrello
elevatore

CONTAINERS CON FONDO APRIBILE A RULLI



■ 01

COD. ART.

PORTATA kg

F ML 0121 00 01

2000

DIM. mm 1000x800x1150 h



■ 01

COD. ART.

PORTATA kg

F ML 0111 00 01

2000

DIM. mm 1000x800x800 h



Esempio di
chiusura del
container con
fondo a rulli



1. apertura totale del fondo



2. inizio chiusura del fondo agevolato da rulli in acciaio



2. chiusura ultimata del fondo

RAL 7000
F. 01

INFO ■

www.famispa.com

LUNGHEZZA = 1000 / 1165 mm

SERIE STORAGE BIG PLAST

CONTAINERS IN PLASTICA

■ ATTENZIONE: NON ADATTI AL CONTENIMENTO DI LIQUIDI CHIMICI



■ 01



COD. ART.

F PT 7040 00 01Coperchi per ART. F PT 1040 00 01 / F PT 1140 00 01 /
F PT 1240 00 01

■ 01



COD. ART.

F PT 7540 00 01Coperchi per ART. F PT 5040 00 01 / F PT 3040 00 01 /
F PT 3140 00 01 / F PT 3240 00 01

Capacità 280 litri

■ 01

COD. ART.

F PT 1040 00 01

PORTATA kg

150

DIM. mm 1000x640x655 h



Capacità 520 litri

■ 01

COD. ART.

F PT 3040 00 01

PORTATA kg

250

DIM. mm 1165x790x800 h



Capacità 520 litri

■ 01

COD. ART.

F PT 5040 00 01

PORTATA kg

300

DIM. mm 1165x790x800 h



Capacità 280 litri

■ 01

COD. ART.

F PT 1140 00 01

DIM. mm

1000x640x790 h

Ø RUOTE mm

100

PORTATA mm

150

Fornito con 4 ruote girevoli senza freno



Capacità 520 litri

■ 01

COD. ART.

F PT 3140 00 01

DIM. mm

1165x790x935 h

Ø RUOTE mm

100

PORTATA mm

200

F PT 3240 00 01 1165x790x960 h 125 250

Fornito con 4 ruote girevoli senza freno

MANIGLIA PER TRASPORTO



■ 01

COD. ART. **F PT 8010 00 01**

Per ART. F PT 1140 00 01 / F PT 1240 00 01

COD. ART. **F PT 8020 00 01**

Per ART. F PT 3140 00 01 / F PT 3240 00 01





